

Ordering catalogue



INNOVATING

India since 1974

Esbee is an ISO 9001:2015 certified company engaged in manufacturing and developing products catering to the needs of general engineering and white goods industry since 1974. Our extensive product portfolio ranges from LED Lighting Solution, Signaling unit, Industrial Push Button Actuators, Enclosures, Switches, Sockets and Wire Harness for variety of applications. We strongly focus on bringing tangible value to our customers through quality, service, and cost control. Along with Indian certifications and approvals, we hold various international approvals such as IEC,UL,TUV,CE,CSA among others.

Innovation is the heart of engineering and we at ESBE strive to keep the heart beating. Every product we design is crafted with innovation and customization according to the customer requirements. Excellent designing and engineering capabilities are our core strength. Furthermore, perfect blend of state of the art infrastructure and dedicated workforce are our major strengths. All these factors facilitate us in making outstanding products to suit the needs of various markets.

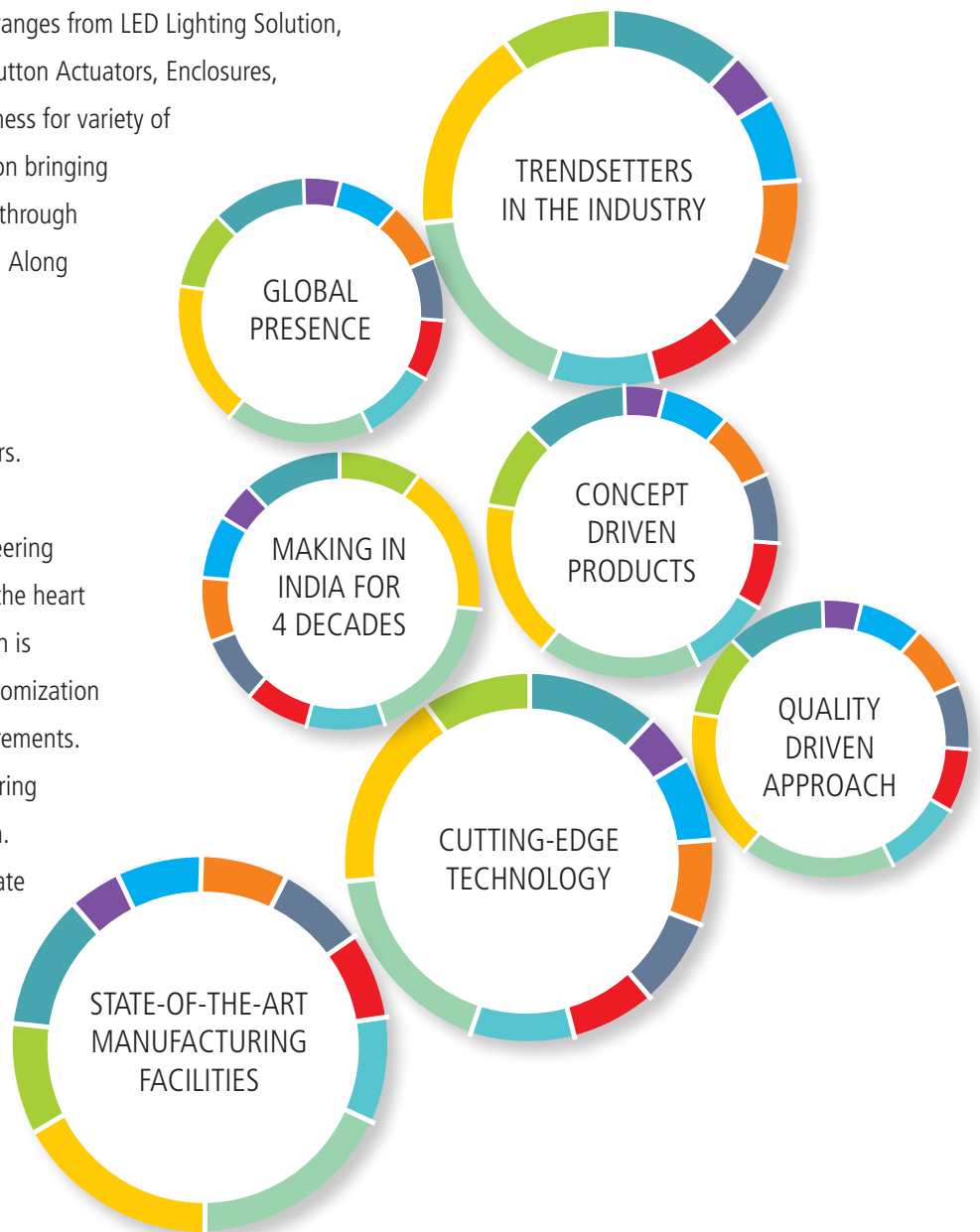



Our Journey

1974

Started with trading activities in a small premises



1982

Manufactured Sync Motors as first product



1983

Establishment of our first plant of 10,000 sq.ft. in Pune



1988

First product enhancement with Push Button manufacturing



1991

Execution of our first export order



1996

Commencement of manufacturing for Industrial HRC Fuses for L&T



2011

Establishment of our second plant of 20,000 sq. ft. in Ahmednagar.



2012

Esbee Industrial Combines converted to Esbee Electrotech LLP



2014

Establishment of the third plant of 40,000 sq. ft. in Pune



2016

Facility enhancement- Introduced SMT Line



2018

Introduced AIS approved Panic and Emergency switches for automobiles.



2019

Facility enhancement- Spectrometer for testing lighting products



2009

Introduction of Gen Next Series for indicators & push button range



2001

Launched TeeKay Series



1998

First delivery of appliance switches



1997

Entered into technical Collaboration with EMB Corporation, U.S.A for appliance switches





Index

LED Indicators.....05-06

PRO Led Indicators	05
Gen Next Led Indicators	05
Panel Mounting Buzzer	06

Gen Next Modular Series..... 07-15

Gen Next Modular Push Button- Illuminated	07
Gen Next Modular Push Button- Non Illuminated.....	09
Emergency Stop-Mushroom Head	10

Gen Next Entegral Series..... 16-22

Push Button Stations..... 23-28

PRO Push Button Stations	23
Enclosures.....	25
Gen Next Push Button Stations.....	26

Lighting Solutions.....29

Led Tube Lights	29
Led Panel Lights.....	29

LED Signaling Units 30-34

Siren Flasher / Siren	30
Tower Lights.....	31

Limit Switches 35-41

SLPB Series	35
SLPS Series.....	36
SLMPB Series	37
SLMB Series	38
SLMS Series	39
MLAS Series.....	39
MLPB Series	40
MNPS Series	41

Elevator Products 42-44

Car Top Box	42
LED Solutions	43
Car Light.....	44
LED with Magnet	44
Emergency Lighting	44

Accessories 45-47

Technical Specifications and product drawings48



Led Indicators

PRO Led Indicators



Panel Cutout 22.5 mm



Features

- Best in class Illumination
- SMD LED cluster technology
- Inbuilt low voltage glow protection
- Power consumption less than 1W
- IP65, IP20
- Witstand 2KV surge & passes 2.5KV HV test for 60 seconds

Voltage	Part No.	Part No.	Part No.	Part No.	Part No.	Part No.	Part No.
12V AC/DC	EPLR012C	EPLG012C	EPLB012C	EPLY012C	EPLA012C	EPLW012C	EPLC012C
24V AC/DC	EPLR024C	EPLG024C	EPLB024C	EPLY024C	EPLA024C	EPLW024C	EPLC024C
30V AC/DC	EPLR030C	EPLG030C	EPLB030C	EPLY030C	EPLA030C	EPLW030C	EPLC030C
48V AC/DC	EPLR048C	EPLG048C	EPLB048C	EPLY048C	EPLA048C	EPLW048C	EPLC048C
64V AC/DC	EPLR064C	EPLG064C	EPLB064C	EPLY064C	EPLA064C	EPLW064C	EPLC064C
110V AC	EPLR110A	EPLG110A	EPLB110A	EPLY110A	EPLA110A	EPLW110A	EPLC110A
110V DC	EPLR110D	EPLG110D	EPLB110D	EPLY110D	EPLA110D	EPLW110D	EPLC110D
240V AC	EPLR240A	EPLG240A	EPLB240A	EPLY240A	EPLA240A	EPLW240A	EPLC240A
220V DC	EPLR220D	EPLG220D	EPLB220D	EPLY220D	EPLA220D	EPLW220D	EPLC220D
415V AC	EPLR415A	EPLG415A	EPLB415A	EPLY415A	EPLA415A	EPLW415A	EPLC415A

Gen Next Led Indicators



Panel Cutout 22.5 mm



Voltage	Part No.	Part No.	Part No.	Part No.	Part No.	Part No.	Part No.
12V AC/DC	EILR012C1	EILG012C1	EILB012C1	EILY012C1	EILA012C1	EILW012C1	EILC012C1
24V AC/DC	EILR024C1	EILG024C1	EILB024C1	EILY024C1	EILA024C1	EILW024C1	EILC024C1
30V AC/DC	EILR030C1	EILG030C1	EILB030C1	EILY030C1	EILA030C1	EILW030C1	EILC030C1
48V AC/DC	EILR048C1	EILG048C1	EILB048C1	EILY048C1	EILA048C1	EILW048C1	EILC048C1
64V AC/DC	EILR064C1	EILG064C1	EILB064C1	EILY064C1	EILA064C1	EILW064C1	EILC064C1
110V AC	EILR110A1	EILG110A1	EILB110A1	EILY110A1	EILA110A1	EILW110A1	EILC110A1
110V DC	EILR110D1	EILG110D1	EILB110D1	EILY110D1	EILA110D1	EILW110D1	EILC110D1
240V AC	EILR240A1	EILG240A1	EILB240A1	EILY240A1	EILA240A1	EILW240A1	EILC240A1
220V DC	EILR220D1	EILG220D1	EILB220D1	EILY220D1	EILA220D1	EILW220D1	EILC220D1
415V AC	EILR415A1	EILG415A1	EILB415A1	EILY415A1	EILA415A1	EILW415A1	EILC415A1

Note: Please refer page no. 48 & 49 For drawings and technical specifications



Universal/Multi-Voltage- Panel Cutout 22.5 mm



Voltage	Part No.	Part No.	Part No.	Part No.	Part No.	Part No.
	●	●	●	●	●	●
24 TO 240V AC/DC	EG0100LR224C	EG0100LG224C	EG0100LB224C	EG0100LY224C	EG0100LA224C	EG0100LW224C
40 TO 240V AC/DC	EG0100LR424C	EG0100LG424C	EG0100LB424C	EG0100LY424C	EG0100LA424C	EG0100LW424C

Panel Cutout 16 mm



Voltage	Part No.	Part No.	Part No.	Part No.	Part No.	Part No.
	●	●	●	●	●	●
12V AC/DC	SILR012C	SILG012C	SILB012C	SILY012C	SILA012C	SILW012C
24V AC/DC	SILR024C	SILG024C	SILB024C	SILY024C	SILA024C	SILW024C
48V AC/DC	SILR048C	SILG048C	SILB048C	SILY048C	SILA048C	SILW048C
64V AC/DC	SILR064C	SILG064C	SILB064C	SILY064C	SILA064C	SILW064C
110V AC/DC	SILR110C	SILG110C	SILB110C	SILY110C	SILA110C	SILW110C
240V AC	SILR240A	SILG240A	SILB240A	SILY240A	SILA240A	SILW240A

Panel Cutout 10 mm

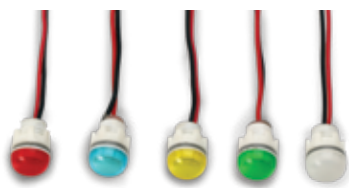

Voltage	Part No.	Part No.	Part No.
	●	●	●
24V AC/DC	BILR024D	BILG024D	BILB024D
Voltage	Part No.	Part No.	Part No.
	●	●	●
24V AC/DC	BILY024D	BILA024D	BILW024D

Note: Also available in 5V DC/12V DC

Note: Please refer page no. 49 To 51 for drawings and technical specifications

Panel Mounting Buzzer with Flasher (Panel Cutout 22.5 mm)



Without Buzzer



Buzzer With Flasher

Colour	Voltage	Part No.
●	12V AC/DC	EG15R00C012C
	24V AC/DC	EG15R00C024C
	30V AC/DC	EG05R00C030C
	48V AC/DC	EG15R00C048C
	64V AC/DC	EG15R00C064C
	110V AC	EG15R00C110A
	240V AC	EG15R00C240A
	24V-240V AC/DC (Universal/Multi-Voltage)	EG15R00C224C

Note: Also available in Red, Amber, Yellow, Green



Gen Next Modular Series



Features

Available in Illuminated/Non-Illuminated

Snap mounting with compact contact blocks (EC1C & EC2C)

Stackable design for Contact Block

Electrical life more than 0.5 million and mechanical life more

than 1.0 million

Inbuilt LVGP (Low Voltage Glow Protection)

Passes surge test 2kV & HV test of 1.5kV

IP 20 terminal protection & IP 65

Gen Next Modular Push Button - Illuminated

Flush Head Actuator



Voltage	Part No.	Part No.	Part No.	Part No.	Part No.	Part No.
12V AC/DC	EG03FDLR012C	EG03FDLG012C	EG03FDLB012C	EG03FDLY012C	EG03FDLA012C	EG03FDLW012C
24V AC/DC	EG03FDLR024C	EG03FDLG024C	EG03FDLB024C	EG03FDLY024C	EG03FDLA024C	EG03FDLW024C
30V AC/DC	EG03FDLR030C	EG03FDLG030C	EG03FDLB030C	EG03FDLY030C	EG03FDLA030C	EG03FDLW030C
48V AC/DC	EG03FDLR048C	EG03FDLG048C	EG03FDLB048C	EG03FDLY048C	EG03FDLA048C	EG03FDLW048C
64V AC/DC	EG03FDLR064C	EG03FDLG064C	EG03FDLB064C	EG03FDLY064C	EG03FDLA064C	EG03FDLW064C
110V AC	EG03FDLR110A	EG03FDLG110A	EG03FDLB110A	EG03FDLY110A	EG03FDLA110A	EG03FDLW110A
110V DC	EG03FDLR110D	EG03FDLG110D	EG03FDLB110D	EG03FDLY110D	EG03FDLA110D	EG03FDLW110D
240V AC	EG03FDLR240A	EG03FDLG240A	EG03FDLB240A	EG03FDLY240A	EG03FDLA240A	EG03FDLW240A
220V DC	EG03FDLR220D	EG03FDLG220D	EG03FDLB220D	EG03FDLY220D	EG03FDLA220D	EG03FDLW220D

Projecting Head Push Function Actuator



Voltage	Part No.	Part No.	Part No.	Part No.	Part No.	Part No.
12V AC/DC	EG03PDLR012C	EG03PDLG012C	EG03PDLB012C	EG03PDLY012C	EG03PDLA012C	EG03PDLW012C
24V AC/DC	EG03PDLR024C	EG03PDLG024C	EG03PDLB024C	EG03PDLY024C	EG03PDLA024C	EG03PDLW024C
30V AC/DC	EG03PDLR030C	EG03PDLG030C	EG03PDLB030C	EG03PDLY030C	EG03PDLA030C	EG03PDLW030C
48V AC/DC	EG03PDLR048C	EG03PDLG048C	EG03PDLB048C	EG03PDLY048C	EG03PDLA048C	EG03PDLW048C
64V AC/DC	EG03PDLR064C	EG03PDLG064C	EG03PDLB064C	EG03PDLY064C	EG03PDLA064C	EG03PDLW064C
110V AC	EG03PDLR110A	EG03PDLG110A	EG03PDLB110A	EG03PDLY110A	EG03PDLA110A	EG03PDLW110A
110V DC	EG03PDLR110D	EG03PDLG110D	EG03PDLB110D	EG03PDLY110D	EG03PDLA110D	EG03PDLW110D
240V AC	EG03PDLR240A	EG03PDLG240A	EG03PDLB240A	EG03PDLY240A	EG03PDLA240A	EG03PDLW240A
220V DC	EG03PDLR220D	EG03PDLG220D	EG03PDLB220D	EG03PDLY220D	EG03PDLA220D	EG03PDLW220D



Twin-Touch Actuator



Voltage	Part No.	Part No.	Part No.
	●	●	○
12V AC/DC	EG03TDLY012C	EG03TDLA012C	EG03TDLC012C
24V AC/DC	EG03TDLY024C	EG03TDLA024C	EG03TDLC024C
30V AC/DC	EG03TDLY030C	EG03TDLA030C	EG03TDLC030C
48V AC/DC	EG03TDLY048C	EG03TDLA048C	EG03TDLC048C
64V AC/DC	EG03TDLY064C	EG03TDLA064C	EG03TDLC064C
110V AC	EG03TDLY110A	EG03TDLA110A	EG03TDLC110A
110V DC	EG03TDLY110D	EG03TDLA110D	EG03TDLC110D
240V AC	EG03TDLY240A	EG03TDLA240A	EG03TDLC240A
220V DC	EG03TDLY220D	EG03TDLA220D	EG03TDLC220D

Selector Actuator



Colour	Voltage	Part No. 2 Position	
		Non-Spring Return	Spring Return
●	24V AC/DC	EG03SKLR024C	EG03SILR024C
	240V AC	EG03SKLR240A	EG03SILR240A
●	24V AC/DC	EG03SKLG024C	EG03SILG024C
	240V AC	EG03SKLG240A	EG03SILG240A

Colour	Voltage	Part No. 3 Position	
		Non-Spring Return	Spring Return
●	24V AC/DC	EG03SLLR024C	EG03SJLR024C
	240V AC	EG03SLLR240A	EG03SJLR240A
●	24V AC/DC	EG03SLLG024C	EG03SJLG024C
	240V AC	EG03SLLG240A	EG03SJLG240A

Note: Also available in various colours- Yellow, Amber, White, Blue & other voltages

Gen Next Led Holder



Voltage	Part No.	Part No.	Part No.	Part No.	Part No.	Part No.
	●	●	●	●	●	●
12V AC/DC	EG08H0LR012C	EG08H0LG012C	EG08H0LB012C	EG08H0LY012C	EG08H0LA012C	EG08H0LW012C
24V AC/DC	EG08H0LR024C	EG08H0LG024C	EG08H0LB024C	EG08H0LY024C	EG08H0LA024C	EG08H0LW024C
30V AC/DC	EG08H0LR030C	EG08H0LG030C	EG08H0LB030C	EG08H0LY030C	EG08H0LA030C	EG08H0LW030C
48V AC/DC	EG08H0LR048C	EG08H0LG048C	EG08H0LB048C	EG08H0LY048C	EG08H0LA048C	EG08H0LW048C
64V AC/DC	EG08H0LR064C	EG08H0LG064C	EG08H0LB064C	EG08H0LY064C	EG08H0LA064C	EG08H0LW064C
110V AC	EG08H0LR110A	EG08H0LG110A	EG08H0LB110A	EG08H0LY110A	EG08H0LA110A	EG08H0LW110A
110V DC	EG08H0LR110D	EG08H0LG110D	EG08H0LB110D	EG08H0LY110D	EG08H0LA110D	EG08H0LW110D
240V AC	EG08H0LR240A	EG08H0LG240A	EG08H0LB240A	EG08H0LY240A	EG08H0LA240A	EG08H0LW240A
220V DC	EG08H0LR220D	EG08H0LG220D	EG08H0LB220D	EG08H0LY220D	EG08H0LA220D	EG08H0LW220D

Note: Please refer page no. 52 For drawings and technical specifications



Gen Next Modular Push Button- Non Illuminated



Flush Head Actuator



Projecting Head Push Function Actuator



Twin-Touch Actuator

Colour	Flush Head Actuator	Projecting Head Push Function Actuator
	EMNRFD1	EMNRPD1
	EMNGFD1	EMNGPD1
	EMNBFD1	EMNBPD1
	EMNYFD1	EMNYPD1
	EMNAFD1	EMNAPD1
	EMNWF1	EMNWP1
	EMNCFD1	EMNCPD1

Colour	Part No.
	EG02TD01

Note: Other combinations available

Selector Actuator



Colour	Part No. 2 Position				Part No. 3 Position			
	Non-Spring Return 30°	Non-Spring Return 45°	Non-Spring Return 90°	Spring Return 30°	Non-Spring Return 30°	Spring Return 30°	Spring Return Left Hand	Spring Return Right Hand
	EMNCSK1	EMNCSR1	EMNCST1	EMNCSI1	EMNCSL1	EMNCSJ1	EMNCSM1	EMNCSN1
	EMNRSK1	EMNRSR1	EMNRST1	EMNRSI1	EMNRSL1	EMNRSJ1	EMNRSM1	EMNRSN1
	EMNGSK1	EMNGSR1	EMNGST1	EMNGSI1	EMNGSL1	EMNGSJ1	EMNGSM1	EMNGSN1
	EMNWSK1	EMNWSR1	EMNWS1	EMNWSI1	EMNWSL1	EMNWSJ1	EMNWSM1	EMNWSN1



Lever Head Actuator



Colour	Part No. 2 Position				Part No. 3 Position			
	Non-Spring Return 30°	Non-Spring Return 45°	Non-Spring Return 90°	Spring Return 30°	Non-Spring Return 30°	Spring Return 30°	Spring Return Left Hand	Spring Return Right Hand
●	EMNCLK1	EMNCLR1	EMNCLT1	EMNCLI1	EMNCLL1	EMNCLJ1	EMNCLM1	EMNCLN1

Lock & Key Rotary Actuator



Colour	Part No. 2 Position				Part No. 3 Position			
	Non-Spring Return 30°	Non-Spring Return 45°	Non-Spring Return 90°	Spring Return 30°	Non-Spring Return 30°	Spring Return 30°	Spring Return Left Hand	Spring Return Right Hand
●	EMNCKK1	EMNCKR1	EMNCKT1	EMNCKI1	EMNCKL1	EMNCKJ1	EMNCKM1	EMNCKN1

Emergency Stop-Mushroom Head



Colour	Mushroom Head Push - Function Actuator	Mushroom Head Push - Turn Actuator	Mushroom Head Push - Turn Actuator - with Mechanical indication	Mushroom Head Push- Pull Actuator - with Mechanical indication	Mushroom Head Push- Pull Actuator	Emergency with Lock & Key
●	EMNRMD1	EMNRMH1	EG09MMH0R00	EG09MMG0R00	EG02MG0R	EG02MQ0R00
●	EMNGMD1	EMNGMH1				
●	EMNYMD1	EMNYMH1				
●	EMNCMD1	EMNCMH1				



Illuminated Legend Plate (Accessory for Mushroom Head Emergency Switch)



Voltage	Part No.	Part No.
	●	●
12V DC	ELLRG012D	
24V DC	ELLRG024D	

Note: Other color options available

Gen Next Contact Blocks



Colour	Contact	Part No.
●	NO	EC1C
	NC	EC2C

Cage Clamp Contact Block



Colour	Contact	Part No.
●	NO	EG08G01C00
	NC	EG08G02C00

PCB Mounted Contact Block

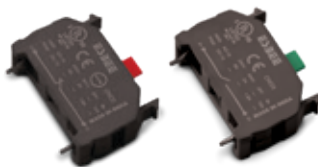

Colour	Contact	Part No.
●	NO	EG08D01C00
	NC	EG08D02C00

Note: Please refer page no. 53 & 54 For drawings and technical specifications



Gen Next Illuminated Actuators

Actuators with PU Coated Collar & Chrome Plated Brass Collar

Colour	"Illuminated Flush Head Actuator with PU Coated Collar"	"Illuminated Projecting Head Push Function Actuator with PU Coated Collar"	"Illuminated Flush Head Actuator with Chrome Plated Brass Collar"	"Illuminated Projecting Head Push Function Actuator with Chrome Plated Brass Collar"
	EG05FD0R00	EG05PD0R00	EG07FD0R00	EG07PD0R00
	EG05FD0G00	EG05PD0G00	EG07FD0G00	EG07PD0G00
	EG05FD0B00	EG05PD0B00	EG07FD0B00	EG07PD0B00
	EG05FD0Y00	EG05PD0Y00	EG07FD0Y00	EG07PD0Y00
	EG05FD0A00	EG05PD0A00	EG07FD0A00	EG07PD0A00
	EG05FD0W00	EG05PD0W00	EG07FD0W00	EG07PD0W00

Selector Actuator with PU Coated Collar

Colour	Part No. 2 Position				Part No. 3 Position			
	Non-Spring Return 30°	Non-Spring Return 45°	Non-Spring Return 90°	Spring Return 30°	Non-Spring Return 30°	Spring Return 30°	Spring Return Left Hand	Spring Return Right Hand
	EG05SK0R00	EG05SR0R00	EG05ST0R00	EG05SI0R00	EG05SL0C00	EG05SJ0R00	EG05SM0R00	EG05SN0R00
	EG05SK0G00	EG05SR0G00	EG05ST0G00	EG05SI0G00	EG05SL0C00	EG05SJ0G00	EG05SM0G00	EG05SN0G00
	EG05SK0B00	EG05SR0B00	EG05ST0B00	EG05SI0B00	EG05SL0B00	EG05SJ0B00	EG05SM0B00	EG05SN0B00
	EG05SK0Y00	EG05SR0Y00	EG05ST0Y00	EG05SI0Y00	EG05SL0Y00	EG05SJ0Y00	EG05SM0Y00	EG05SN0Y00
	EG05SK0W00	EG05SR0W00	EG05ST0W00	EG05SI0W00	EG05SL0C00	EG05SJ0W00	EG05SM0W00	EG05SN0W00

Selector Actuator with Chrome Plated Brass Collar

Colour	Part No. 2 Position				Part No. 3 Position			
	Non-Spring Return 30°	Non-Spring Return 45°	Non-Spring Return 90°	Spring Return 30°	Non-Spring Return 30°	Spring Return 30°	Spring Return Left Hand	Spring Return Right Hand
	EG07SK0R00	EG07SR0R00	EG07ST0R00	EG07SI0R00	EG07SL0C00	EG07SJ0R00	EG07SM0R00	EG07SN0R00
	EG07SK0G00	EG07SR0G00	EG07ST0G00	EG07SI0G00	EG07SL0C00	EG07SJ0G00	EG07SM0G00	EG07SN0G00
	EG07SK0B00	EG07SR0B00	EG07ST0B00	EG07SI0B00	EG07SL0B00	EG07SJ0B00	EG07SM0B00	EG07SN0B00
	EG07SK0Y00	EG07SR0Y00	EG07ST0Y00	EG07SI0Y00	EG07SL0Y00	EG07SJ0Y00	EG07SM0Y00	EG07SN0Y00
	EG07SK0W00	EG07SR0W00	EG07ST0W00	EG07SI0W00	EG07SL0C00	EG07SJ0W00	EG07SM0W00	EG07SN0W00



Gen Next Non-Illuminated Actuators

Actuators with PU coated collar

Actuators with Chrome plated Brass Collar



Colour	"Flush Head Actuator with PU Coated collar"	"Projecting Head Push Function Actuator with PU Coated collar"	"Flush Head Actuator with chrome plated Brass collar"	"Projecting Head Push Function Actuator with chrome plated Brass collar"
	EG04FD0R00	EG04PD0R00	EG06FD0R00	EG06PD0R00
	EG04FD0G00	EG04PD0G00	EG06FD0G00	EG06PD0G00
	EG04FD0B00	EG04PD0B00	EG06FD0B00	EG06PD0B00
	EG04FD0Y00	EG04PD0Y00	EG06FD0Y00	EG06PD0Y00
	EG04FD0A00	EG04PD0A00	EG06FD0A00	EG06PD0A00
	EG04FD0W00	EG04PD0W00	EG06FD0W00	EG06PD0W00
	EG04FD0C00	EG04PD0C00	EG06FD0C00	EG06PD0C00

Selector Actuator with PU Coated Collar

Colour	Part No. 2 Position				Part No. 3 Position			
	Non-Spring Return 30°	Non-Spring Return 45°	Non-Spring Return 90°	Spring Return 30°	Non-Spring Return 30°	Spring Return 30°	Spring Return Left Hand	Spring Return Right Hand
	EG04SK0C00	EG04SR0C00	EG04ST0C00	EG04SI0C00	EG04SL0C00	EG04SJ0C00	EG04SM0C00	EG04SN0C00
	EG04SK0R00	EG04SR0R00	EG04ST0R00	EG04SI0R00	EG04SL0C00	EG04SJ0R00	EG04SM0R00	EG04SN0R00
	EG04SK0G00	EG04SR0G00	EG04ST0G00	EG04SI0G00	EG04SL0C00	EG04SJ0G00	EG04SM0G00	EG04SN0G00
	EG04SK0W00	EG04SR0W00	EG04ST0W00	EG04SI0W00	EG04SL0C00	EG04SJ0W00	EG04SM0W00	EG04SN0W00



Selector Actuator with Chrome plated Brass Collar

Colour	Selector Actuator 2 Position				Selector Actuator 3 Position			
	Non-Spring Return 30°	Non-Spring Return 45°	Non-Spring Return 90°	Spring Return 30°	Non-Spring Return 30°	Spring Return 30°	Spring Return Left Hand	Spring Return Right Hand
●	EG06SK0C00	EG06SR0C00	EG06ST0C00	EG06SI0C00	EG06SL0C00	EG06SJ0C00	EG06SM0C00	EG06SN0C00
●	EG06SK0R00	EG06SR0R00	EG06ST0R00	EG06SI0R00	EG06SL0C00	EG06SJ0R00	EG06SM0R00	EG06SN0R00
●	EG06SK0G00	EG06SR0G00	EG06ST0G00	EG06SI0G00	EG06SL0C00	EG06SJ0G00	EG06SM0G00	EG06SN0G00
●	EG06SK0W00	EG06SR0W00	EG06ST0W00	EG06SI0W00	EG06SL0C00	EG06SJ0W00	EG06SM0W00	EG06SN0W00

Lever Head Actuator with PU Coated Collar

Colour	Part No. 2 Position				Part No. 3 Position			
	Non-Spring Return 30°	Non-Spring Return 45°	Non-Spring Return 90°	Spring Return 30°	Non-Spring Return 30°	Spring Return 30°	Spring Return Left Hand	Spring Return Right Hand
●	EG04LK0C00	EG04LR0C00	EG04LT0C00	EG04LI0C00	EG04LL0C00	EG04LJ0C00	EG04LM0C00	EG04LN0C00

Lever Head Actuator with Chrome plated Brass Collar

Colour	Part No. 2 Position				Part No. 3 Position			
	Non-Spring Return 30°	Non-Spring Return 45°	Non-Spring Return 90°	Spring Return 30°	Non-Spring Return 30°	Spring Return 30°	Spring Return Left Hand	Spring Return Right Hand
●	EG06LK0C00	EG06LR0C00	EG06LT0C00	EG06LI0C00	EG06LL0C00	EG06LJ0C00	EG06LM0C00	EG06LN0C00



Lock & Key Actuator with PU Coated Collar

Colour	Part No. 2 Position				Part No. 3 Position			
	Non-Spring Return 30°	Non-Spring Return 45°	Non-Spring Return 90°	Spring Return 30°	Non-Spring Return 30°	Spring Return 30°	Spring Return Left Hand	Spring Return Right Hand
●	EG04KK0C01	EG04KR0C01	EG04KT0C01	EG04KI0C01	EG04KL0C01	EG04KJ0C01	EG04KM0C01	EG04KN0C01

Lock & Key Actuator with Chrome plated Brass Collar

Colour	Part No. 2 Position				Part No. 3 Position			
	Non-Spring Return 30°	Non-Spring Return 45°	Non-Spring Return 90°	Spring Return 30°	Non-Spring Return 30°	Spring Return 30°	Spring Return Left Hand	Spring Return Right Hand
●	EG06KK0C01	EG06KR0C01	EG06KT0C01	EG06KI0C01	EG06KL0C01	EG06KJ0C01	EG06KM0C01	EG06KN0C01



Gen Next Entegral Series



Flush Head



Features

Isolated terminals for NO+NC Application

Current rating of 6A at 240V AC

IP 20 terminal Protection & IP 65

Electrical operation 0.5 million at rated voltage, mechanical life of 1 million operations

Contact	Part No.	Part No.	Part No.	Part No.	Part No.	Part No.	Part No.
1NO	EE1RFD1	EE1GFD1	EE1BFD1	EE1YFD1	EE1AFD1	EE1WFD1	EE1CFD1
1NC	EE2RFD1	EE2GFD1	EE2BFD1	EE2YFD1	EE2AFD1	EE2WFD1	EE2CFD1
1NO+1NC	EE3RFD1	EE3GFD1	EE3BFD1	EE3YFD1	EE3AFD1	EE3WFD1	EE3CFD1
2NO	EE4RFD1	EE4GFD1	EE4BFD1	EE4YFD1	EE4AFD1	EE4WFD1	EE4CFD1
2NC	EE5RFD1	EE5GFD1	EE5BFD1	EE5YFD1	EE5AFD1	EE5WFD1	EE5CFD1

Projecting Head Push Function



Contact	Part No.	Part No.	Part No.	Part No.	Part No.	Part No.	Part No.
1NO	EE1RPD1	EE1GPD1	EE1BPD1	EE1YPD1	EE1APD1	EE1WPD1	EE1CPD1
1NC	EE2RPD1	EE2GPD1	EE2BPD1	EE2YPD1	EE2APD1	EE2WPD1	EE2CPD1
1NO+1NC	EE3RPD1	EE3GPD1	EE3BPD1	EE3YPD1	EE3APD1	EE3WPD1	EE3CPD1
2NO	EE4RPD1	EE4GPD1	EE4BPD1	EE4YPD1	EE4APD1	EE4WPD1	EE4CPD1
2NC	EE5RPD1	EE5GPD1	EE5BPD1	EE5YPD1	EE5APD1	EE5WPD1	EE5CPD1

Pro Push Turn Entegral



Contact	Part No.	Part No.	Part No.	Part No.
1NC	EE09AH1R00	EE09AH1G00	EE09AH1Y00	EE09AH1C00
1NO	EE09AH2R00	EE09AH2G00	EE09AH2Y00	EE09AH2C00
1NO+1NC	EE09AH3R00	EE09AH3G00	EE09AH3Y00	EE09AH3C00
2NO	EE09AH4R00	EE09AH4G00	EE09AH4Y00	EE09AH4C00
2NC	EE09AH5R00	EE09AH5G00	EE09AH5Y00	EE09AH5C00

Mushroom Head Push Pull



Contact	Part No.
1NC	EE04MG2R00
1NO+1NC	EE04MG3R00
2NC	EE04MG5R00

Note: Other contact combinations available



Mushroom Head Push Function



Contact	Part No.	Part No.	Part No.	Part No.
	●	●	●	●
1NO	EE1RMD1	EE1GMD1	EE1YMD1	EE1CMD1
1NC	EE2RMD1	EE2GMD1	EE2YMD1	EE2CMD1
1NO+1NC	EE3RMD1	EE3GMD1	EE3YMD1	EE3CMD1
2NO	EE4RMD1	EE4GMD1	EE4YMD1	EE4CMD1
2NC	EE5RMD1	EE5GMD1	EE5YMD1	EE5CMD1

Symmetric Head



Colour	Contact	Part No. 2 Position				Part No. 3 Position			
		Non-Spring Return 30°	Non-Spring Return 45°	Non-Spring Return 90°	Spring Return 30°	Non-Spring Return 30°	Spring Return 30°	Spring Return Left Hand	Spring Return Right Hand
●	1NO	EE1CSK1	EE1CSR1	EE1CST1	EE1CSI1	EE1CSL1	EE1CSJ1	EE1CSM1	EE1CSN1
	1NC	EE2CSK1	EE2CSR1	EE2CST1	EE2CSI1	EE2CSL1	EE2CSJ1	EE2CSM1	EE2CSN1
	1NO+1NC	EE3CSK1	EE3CSR1	EE3CST1	EE3CSI1	EE3CSL1	EE3CSJ1	EE3CSM1	EE3CSN1
	2NO	EE4CSK1	EE4CSR1	EE4CST1	EE4CSI1	EE4CSL1	EE4CSJ1	EE4CSM1	EE4CSN1
	2NC	EE5CSK1	EE5CSR1	EE5CST1	EE5CSI1	EE5CSL1	EE5CSJ1	EE5CSM1	EE5CSN1

Lever Head



Colour	Contact	Part No. 2 Position		Part No. 3 Position			
		Non-Spring Return 30°	Spring Return 30°	Non-Spring Return 30°	Spring Return 30°	Spring Return Left Hand	Spring Return Right Hand
●	1NO	EE1CLK1	EE1CLI1	EE1CLL1	EE1CLJ1	EE1CLM1	EE1CLN1
	1NC	EE2CLK1	EE2CLI1	EE2CLL1	EE2CLJ1	EE2CLM1	EE2CLN1
	1NO+1NC (LEFT NO)	EE3CLK1	EE3CLI1	EE3CLL1	EE3CLJ1	EE3CLM1	EE3CLN1
	2NO	EE4CLK1	EE4CLI1	EE4CLL1	EE4CLJ1	EE4CLM1	EE4CLN1
	2NC	EE5CLK1	EE5CLI1	EE5CLL1	EE5CLJ1	EE5CLM1	EE5CLN1
	1NO+1NC (RIGHT NO)	EE6CLK1	EE6CLI1	EE6CLL1	EE6CLJ1	EE6CLM1	EE6CLN1



Lock and Key



Colour	Contact	Part No. 2 Position		Part No. 3 Position			
		Non-Spring Return 30°	Spring Return 30°	Non-Spring Return 30°	Spring Return 30°	Spring Return Left Hand	Spring Return Right Hand
●	1NO	EE1CKK1	EE1CKI1	EE1CKL1	EE1CKJ1	EE1CKM1	EE1CKN1
	1NC	EE2CKK1	EE2CKI1	EE2CKL1	EE2CKJ1	EE2CKM1	EE2CKN1
	1NO+1NC (LEFT NO)	EE3CKK1	EE3CKI1	EE3CKL1	EE3CKJ1	EE3CKM1	EE3CKN1
	2NO	EE4CKK1	EE4CKI1	EE4CKL1	EE4CKJ1	EE4CKM1	EE4CKN1
	2NC	EE5CKK1	EE5CKI1	EE5CKL1	EE5CKJ1	EE5CKM1	EE5CKN1
	1NO+1NC (RIGHT NO)	EE6CKK1	EE6CKI1	EE6CKL1	EE6CKJ1	EE6CKM1	EE6CKN1

Note: Please refer page no. 57 For drawings and technical specifications



Gen Next Entegral Series with PU Coated Collar & Chrome Plated Brass Collar

Entegral Actuators with PU Coated Collar



Entegral Actuators with Chrome plated Brass Collar



Flush Head Entegral Actuators with PU Coated Collar

Contact	Part No.	Part No.	Part No.	Part No.	Part No.	Part No.	Part No.
1NO	EE04FD1R	EE04FD1G	EE04FD1B	EE04FD1Y	EE04FD1A	EE04FD1W	EE04FD1C
1NC	EE04FD2R	EE04FD2G	EE04FD2B	EE04FD2Y	EE04FD1A	EE04FD2W	EE04FD2C
1NO+1NC	EE04FD3R	EE04FD3G	EE04FD3B	EE04FD3Y	EE04FD1A	EE04FD3W	EE04FD3C
2NO	EE04FD4R	EE04FD4G	EE04FD4B	EE04FD4Y	EE04FD1A	EE04FD4W	EE04FD4C
2NC	EE04FD5R	EE04FD5G	EE04FD5B	EE04FD5Y	EE04FD1A	EE04FD5W	EE04FD5C

Flush Head Entegral Actuators with Chrome plated Brass Collar

Contact	Part No.	Part No.	Part No.	Part No.	Part No.	Part No.	Part No.
1NO	EE06FD1R	EE06FD1G	EE06FD1B	EE06FD1Y	EE06FD1A	EE06FD1W	EE06FD1C
1NC	EE06FD2R	EE06FD2G	EE06FD2B	EE06FD2Y	EE06FD1A	EE06FD2W	EE06FD2C
1NO+1NC	EE06FD3R	EE06FD3G	EE06FD3B	EE06FD3Y	EE06FD1A	EE06FD3W	EE06FD3C
2NO	EE06FD4R	EE06FD4G	EE06FD4B	EE06FD4Y	EE06FD1A	EE06FD4W	EE06FD4C
2NC	EE06FD5R	EE06FD5G	EE06FD5B	EE06FD5Y	EE06FD1A	EE06FD5W	EE06FD5C

Projecting Head Entegral Actuators with PU Coated Collar

Contact	Part No.	Part No.	Part No.	Part No.	Part No.	Part No.	Part No.
1NO	EE04PD1R	EE04PD1G	EE04PD1B	EE04PD1Y	EE04PD1A	EE04PD1W	EE04PD1C
1NC	EE04PD2R	EE04PD2G	EE04PD2B	EE04PD2Y	EE04PD1A	EE04PD2W	EE04PD2C
1NO+1NC	EE04PD3R	EE04PD3G	EE04PD3B	EE04PD3Y	EE04PD1A	EE04PD3W	EE04PD3C
2NO	EE04PD4R	EE04PD4G	EE04PD4B	EE04PD4Y	EE04PD1A	EE04PD4W	EE04PD4C
2NC	EE04PD5R	EE04PD5G	EE04PD5B	EE04PD5Y	EE04PD1A	EE04PD5W	EE04PD5C

Projecting Head Entegral Actuators with Chrome plated Brass Collar

Contact	Part No.	Part No.	Part No.	Part No.	Part No.	Part No.	Part No.
1NO	EE06PD1R	EE06PD1G	EE06PD1B	EE06PD1Y	EE06PD1A	EE06PD1W	EE06PD1C
1NC	EE06PD2R	EE06PD2G	EE06PD2B	EE06PD2Y	EE06PD1A	EE06PD2W	EE06PD2C
1NO+1NC	EE06PD3R	EE06PD3G	EE06PD3B	EE06PD3Y	EE06PD1A	EE06PD3W	EE06PD3C
2NO	EE06PD4R	EE06PD4G	EE06PD4B	EE06PD4Y	EE06PD1A	EE06PD4W	EE06PD4C
2NC	EE06PD5R	EE06PD5G	EE06PD5B	EE06PD5Y	EE06PD1A	EE06PD5W	EE06PD5C



Selector Integral Actuators with PU Coated Collar

Colour	Contact	Part No. 2 Position				Part No. 3 Position			
		Non-Spring Return 30°	Non-Spring Return 45°	Non-Spring Return 90°	Spring Return 30°	Non-Spring Return 30°	Spring Return 30°	Spring Return Left Hand	Spring Return Right Hand
●	1NO	EE04SK1C	EE04SR1C	EE04ST1C	EE04SI1C	EE04SL1C	EE04SJ1C	EE04SM1C	EE04SN1C
	1NC	EE04SK2C	EE04SR2C	EE04ST2C	EE04SI2C	EE04SL2C	EE04SJ2C	EE04SM2C	EE04SN2C
	1NO+1NC	EE04SK3C	EE04SR3C	EE04ST3C	EE04SI3C	EE04SL3C	EE04SJ3C	EE04SM3C	EE04SN3C
	2NO	EE04SK4C	EE04SR4C	EE04ST4C	EE04SI4C	EE04SL4C	EE04SJ4C	EE04SM4C	EE04SN4C
	2NC	EE04SK5C	EE04SR5C	EE04ST5C	EE04SI5C	EE04SL5C	EE04SJ5C	EE04SM5C	EE04SN5C

Selector Integral Actuators with Chrome plated Brass Collar

Colour	Contact	Part No. 2 Position				Part No. 3 Position			
		Non-Spring Return 30°	Non-Spring Return 45°	Non-Spring Return 90°	Spring Return 30°	Non-Spring Return 30°	Spring Return 30°	Spring Return Left Hand	Spring Return Right Hand
●	1NO	EE06SK1C	EE06SR1C	EE06ST1C	EE06SI1C	EE06SL1C	EE06SJ1C	EE06SM1C	EE04SN1C
	1NC	EE06SK2C	EE06SR2C	EE06ST2C	EE06SI2C	EE06SL2C	EE06SJ2C	EE06SN2C	EE04SN2C
	1NO+1NC	EE06SK3C	EE06SR3C	EE06ST3C	EE06SI3C	EE06SL3C	EE06SJ3C	EE06SN3C	EE04SN3C
	2NO	EE06SK4C	EE06SR4C	EE06ST4C	EE06SI4C	EE06SL4C	EE06SJ4C	EE06SN4C	EE04SN4C
	2NC	EE06SK5C	EE06SR5C	EE06ST5C	EE06SI5C	EE06SL5C	EE06SJ5C	EE06SN5C	EE04SN5C



Lever Head Entegral Actuators with PU Coated Collar

Colour	Contact	Part No. 2 Position				Part No. 3 Position			
		Non-Spring Return 30°	Non-Spring Return 45°	Non-Spring Return 90°	Spring Return 30°	Non-Spring Return 30°	Spring Return 30°	Spring Return Left Hand	Spring Return Right Hand
●	1NO	EE04LK1C	EE04LR1C	EE04LT1C	EE04LI1C	EE04LL1C	EE04LJ1C	EE04LM1C	EE04LN1C
	1NC	EE04LK2C	EE04LR2C	EE04LT2C	EE04LI2C	EE04LL2C	EE04LJ2C	EE04LN2C	EE04LN2C
	1NO+1NC	EE04LK3C	EE04LR3C	EE04LT3C	EE04LI3C	EE04LL3C	EE04LJ3C	EE04LN3C	EE04LN3C
	2NO	EE04LK4C	EE04LR4C	EE04LT4C	EE04LI4C	EE04LL4C	EE04LJ4C	EE04LN4C	EE04LN4C
	2NC	EE04LK5C	EE04LR5C	EE04LT5C	EE04LI5C	EE04LL5C	EE04LJ5C	EE04LN5C	EE04LN5C

Lever Head Entegral Actuators with Chrome plated Brass Collar

Colour	Contact	Part No. 2 Position				Part No. 3 Position			
		Non-Spring Return 30°	Non-Spring Return 45°	Non-Spring Return 90°	Spring Return 30°	Non-Spring Return 30°	Spring Return 30°	Spring Return Left Hand	Spring Return Right Hand
●	1NO	EE06LK1C	EE06LR1C	EE06LT1C	EE06LI1C	EE06LL1C	EE06LJ1C	EE06LM1C	EE06LN1C
	1NC	EE06LK2C	EE06LR2C	EE06LT2C	EE06LI2C	EE06LL2C	EE06LJ2C	EE06LN2C	EE06LN2C
	1NO+1NC	EE06LK3C	EE06LR3C	EE06LT3C	EE06LI3C	EE06LL3C	EE06LJ3C	EE06LN3C	EE06LN3C
	2NO	EE06LK4C	EE06LR4C	EE06LT4C	EE06LI4C	EE06LL4C	EE06LJ4C	EE06LN4C	EE06LN4C
	2NC	EE06LK5C	EE06LR5C	EE06LT5C	EE06LI5C	EE06LL5C	EE06LJ5C	EE06LN5C	EE06LN5C



Lock & Key Integral Actuators with PU Coated Collar

Colour	Contact	Part No. 2 Position				Part No. 3 Position			
		Non-Spring Return 30°	Non-Spring Return 45°	Non-Spring Return 90°	Spring Return 30°	Non-Spring Return 30°	Spring Return 30°	Spring Return Left Hand	Spring Return Right Hand
●	1NO	EE04KK1C	EE04KR1C	EE04KT1C	EE04K11C	EE04KL1C	EE04KJ1C	EE04KM1C	EE04KN1C
	1NC	EE04KK2C	EE04KR2C	EE04KT2C	EE04K12C	EE04KL2C	EE04KJ2C	EE04KN2C	EE04KN2C
	1NO+1NC	EE04KK3C	EE04KR3C	EE04KT3C	EE04K13C	EE04KL3C	EE04KJ3C	EE04KN3C	EE04KN3C
	2NO	EE04KK4C	EE04KR4C	EE04KT4C	EE04K14C	EE04KL4C	EE04KJ4C	EE04KN4C	EE04KN4C
	2NC	EE04KK5C	EE04KR5C	EE04KT5C	EE04K15C	EE04KL5C	EE04KJ5C	EE04KN5C	EE04KN5C

Lock & Key Integral Actuators with Chrome plated Brass Collar

Colour	Contact	Part No. 2 Position				Part No. 3 Position			
		Non-Spring Return 30°	Non-Spring Return 45°	Non-Spring Return 90°	Spring Return 30°	Non-Spring Return 30°	Spring Return 30°	Spring Return Left Hand	Spring Return Right Hand
●	1NO	EE06KK1C	EE06KR1C	EE06KT1C	EE06K11C	EE06KL1C	EE06KJ1C	EE06KM1C	EE06KN1C
	1NC	EE06KK2C	EE06KR2C	EE06KT2C	EE06K12C	EE06KL2C	EE06KJ2C	EE06KN2C	EE06KN2C
	1NO+1NC	EE06KK3C	EE06KR3C	EE06KT3C	EE06K13C	EE06KL3C	EE06KJ3C	EE06KN3C	EE06KN3C
	2NO	EE06KK4C	EE06KR4C	EE06KT4C	EE06K14C	EE06KL4C	EE06KJ4C	EE06KN4C	EE06KN4C
	2NC	EE06KK5C	EE06KR5C	EE06KT5C	EE06K15C	EE06KL5C	EE06KJ5C	EE06KN5C	EE06KN5C



Push Button Stations



PRO Push Button Stations



Features

External mounting

High impact material ABS engineering plastic

Comply with safety IEC standards with IP 65 Ingress protection

Fully Insulated to house electrical and electronic equipment

Single Station



Flush Head Actuator



Two Position Symmetric Head Selector Switch



Two Position Lock & Key Rotary Switch



Mushroom Head Actuator 'Push Function'

	Flush Head Actuator		Two Position Symmetric Head Selector Switch	Two Position Lock & Key Rotary Switch	Mushroom Head Actuator 'Push Function'
Colour					
Legend	STOP	START	OFF / ON	OFF / ON	STOP
Contact	1 NC	1 'NO'	1 NO	1 NO	1 NC
Cat. No.	EWS1C01AC062	EWS1C01AC063	EWS1C01AF064	EWS1C01AF065	EWS1C13AC054



Mushroom Head Actuator 'Push Turn Type'



Mushroom Head Actuator with Lock & Key



Mushroom Head Push Pull

	Mushroom Head Actuator 'Push Turn Type'	Mushroom Head Actuator with Lock & Key	Mushroom Head Push Pull
Colour			
Legend	STOP	STOP	STOP
Contact	1 NC	1 NC	1 NC
Cat. No.	EWS1C13AC051	EWS1C13AC066	EWS1C13AC069

Note: More contacts/printing & combination available based on customer requirement. Please be in touch with our sales team for the same.



Two Station



Flush Head Actuator



Flush Head Actuator/
Mushroom Head Lock
& Key Actuator



Flush Head Actuator/Mushroom
Head Actuator Push Turn Type

	Flush Head Actuator		Flush Head Actuator	Mushroom Head Lock & Key Actuator	Flush Head Actuator	Mushroom Head Actuator Push Turn Type
Colour						
Legend	START	STOP	START	STOP	START	STOP
Contact	1 NO	1 NC	1 NO	1 NC	1 NO	1 NC
Cat. No.	EWS2C01AH045		EWS2C01AH068		EWS2C01AH067	

Three Station



LED Indicator 240V AC/
Flush Head Actuator



Flush Head Actuator

	LED Indicator 240V AC	Flush Head Actuator		Flush Head Actuator		
Colour						
Legend		START	STOP	FORWARD	STOP	REVERSE
Contact		1 NO	1 NC	1 NO	1 NC	1 NO
Cat. No.		EWS3C01AH048		EWS3C01BJ055		

Note: More contacts/printing & combinations are available based on customer requirement. Please contact our sales team for the same.



Flush Head Actuator

Flush Head Actuator			
Colour			
Legend	UP	STOP	DOWN
Contact	1 NO	1 NC	1 NO
Cat. No.	EWS3C01AS055		

Enclosures

Pro Enclosures

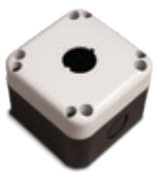

75x75x56mm



127x75x56mm



160x75x56mm



215x75x70mm



270x75x71mm

22.5 Hole / Colour	Grey / Black	Yellow / Black
Single Hole of 22.5mm	EWS1C01AA	EWS1C13AA
Two Hole of 22.5mm	EWS2C01AA	EWS2C13AA
Three Hole of 22.5mm	EWS3C01AA	EWS3C13AA
Four Hole of 22.5mm	EWS4C01AA	EWS4C13AA
Five Hole of 22.5mm	EWS5C01AA	EWS5C13AA

All Purpose Enclosures



110x80x65mm

All Purpose Enclosures	
All Grey Without hole	
Cat. No.	HF999000
All Grey & 1 hole of Ø22.5	
Cat. No.	HF999001
All Grey & 2 holes of Ø22.5	
Cat. No.	HF999002

Note: Please refer page no. 58 to 60 and 62 for drawings and technical specifications



Gen Next Push Button Stations

Features

Sleek, Compact & Unique design

Good aesthetics, occupies less space

Easy to grip, assemble & operate

Robust & maintenance free

Comply with safety IEC standards with IP 65 ingress protection

Available range of enclosures single, two, three & eight station

Single Station







Flush Head Actuator



Two Position Symmetric Head



Two Position Lock & Key



	Flush Head Actuator		Two Position Symmetric Head	Two Position Lock & Key
Colour				
Legend	STOP	START	OFF / ON	OFF / ON
Contact	1 NC	1 NO	1 NO	1 NO
Cat. No.	EP1FAC01	EP1FAB02	EP1FAF08	EP1FAF12



Mushroom Head Actuator (Push Turn Type)



Mushroom Head Actuator (Push Function)

	Mushroom Head Actuator (Push Turn Type)	Mushroom Head Actuator (Push Function)
Colour		
Legend	STOP	STOP
Contact	1 NC	1 NC
Cat. No.	EP1FAC05	EP1FAC03

Note: More contacts/printing & combinations are available based on customer requirement. Please contact our sales team for the same.



Two Station



Flush Head Actuator





Mushroom Head Actuator

Flush Head Actuator		Mushroom Head Actuator	
Colour			
Legend	START	STOP	STOP
Contact	1 NO	1 NC	1 NC
Cat. No.	EP2FAH0201		EP2FAH0205

Three Station



LED Indicator 240V AC / Flush Head Actuator



LED Indicator 240V AC		Flush Head Actuator	
Colour			
Legend		START	STOP
Contact		1 NO	1 NC
Cat. No.	EP3FAUI1X0201		

Flush Head Actuator



Flush Head Actuator			
Colour			
Legend	FORWARD	STOP	REVERSE
Contact	1 NO	1 NC	1 NO
Cat. No.	EP3FAR020102		

Note: More contacts/printing & combination available based on customer requirement. Please be in touch with our sales team for the same.



Flush Head Actuator			
Colour			
Legend	UP	STOP	DOWN
Contact	1 NO	1 NC	1 NO
Cat. No.	EP3FAS020102		

Eight Station



7 Flush Head Actuators with NO contact each & Mushroom Head Push Turn with NC contact	
Cat. No.	EP8F02

7 Flush Head Actuators with NO contact each & Mushroom Head Push Turn with NC contact (with provision for hanging)	
Cat. No.	EP8F04

Gen Next Enclosures



Enclosures	Grey and Black	Yellow and Black
One Hole	EP1FAA	EP1C3AA000
Two Hole	EP2FAA	EP2C3AA000
Three Hole	EP3FAA	EP3C3AA000
Eight Hole	EP8FAA	EP8C3AA000

Note: All Gen Next Push Button Stations are assembled with Entegral Actuators. All Gen Next Enclosures can be assembled only with Entegral Actuators

Note: More contacts/printing & combinations are available based on customer requirement. Please contact our sales team for the same.

Note: Please refer page no. 61 To 62 for drawings and technical specifications



Lighting Solutions

Led Tube Lights



150mm

1 Foot

2 Feet

4 Feet



Product	Type	CAT No.
150mm, 3 Watt	Square Type	IT503WCWBMSC240A00
	Flower Type	IT503WCWBMGN240A00
1 Foot, 5 Watt	Square Type	IT505WCW1MSC240A00
	Flower Type	IT505WCW1MGN240A00
	Square Type with connector	IT505WCW1MSC240A01
1 Foot, 9 Watt	Square Type	IT509WCW1MSC240A00
	Flower Type	IT509WCW1MGN240A00
2 Feet, 12 Watt	Square Type	IT512WCW2MSC240A00
	Flower Type	IT512WCW2MGN240A00
4 Feet, 16 Watt	Square Type	IT516WCW4MSC240A00
	Flower Type	IT516WCW4MGN240A00

Features

Energy saving, bright, eco-friendly LED tube lights

Designed and manufactured in India with high quality and precision

Available in unique shape

Different sizes available

Available in cool white and warm white

Square batten LED tube light available with cascading features

Led Panel Lights



LED Panel Light with Bracket



LED Panel Light with Magnet

Features

Completely assembled product. Ready to use

Product made of engineering plastic making it more robust, impact proof, corrosion resistance & fire retardant

Sustain 2.5KV of surge & 4KV of EFT

Cascading options available

Options available with battery and motion sensors

Housing Colour	LED Panel Light				Led Panel Light, cascading unit	
	Voltage	With Bracket (ON -OFF Switch)	With Bracket (W/O ON-OFF Switch)	With Magnet	With Bracket	With Magnet
●	012V DC	IC24A03W012D	IC24A29W012D	IC24A04W012D	IC24A11W012D	IC24A12W012D
	024V DC	IC24A03W024D	IC24A29W024D	IC24A04W024D	IC24A11W024D	IC24A12W024D
	110V AC	IC24A03W110A	IC24A29W110A	IC24A04W110A	IC24A11W110A	IC24A12W110A
	240V AC	IC24A03W240A	IC24A29W240A	IC24A04W240A	IC24A11W240A	IC24A12W240A
●	012V DC	IC24A03J012D	IC24A29J012D	IC24A04J012D	IC24A11J012D	IC24A12J012D
	024V DC	IC24A03J024D	IC24A29J024D	IC24A04J024D	IC24A11J024D	IC24A12J024D
	110V AC	IC24A03J110A	IC24A29J110A	IC24A04J110A	IC24A11J110A	IC24A12J110A
	240V AC	IC24A03J240A	IC24A29J240A	IC24A04J240A	IC24A11J240A	IC24A12J240A
●	012V DC	IC24A03C012D	IC24A29C012D	IC24A04C012D	IC24A11C012D	IC24A12C012D
	024V DC	IC24A03C024D	IC24A29C024D	IC24A04C024D	IC24A11C024D	IC24A12C024D
	110V AC	IC24A03C110A	IC24A29C110A	IC24A04C110A	IC24A11C110A	IC24A12C110A
	240V AC	IC24A03C240A	IC24A29C240A	IC24A04C240A	IC24A11C240A	IC24A12C240A

Note: Please refer page no. 63 & 64 For drawings and technical specifications



LED Signaling Units

Siren Flasher / Siren

Features

Sleek design

SMD LED Technology

Available in all Colours ,Flashing and Rotary integrated LED modules are available

IP 65 protection

Siren Flasher - 100 dB
sound output  



Emergency Siren with LED Flasher

Voltage	Part No.
240V AC	IA12M34R240A
110V AC	IA12M34R110A
24V DC	IA12M34R024D

Siren-100 dB Sound
output  



Emergency Siren

Voltage	Part No.
240V AC	IA00040C240A
110V AC	IA00040C110A
24V DC	IA00040C024C

Note: Available in different colours

Note: Please refer page no. 65 For drawings and technical specifications



Tower Lights

Diameter- 50mm



Choose Different Colours and set your own Combo

Features

Sleek & Stackable design

SMD LED Technology for uniform & bright illumination

Flexibility to upgrade from Single LED units to multiple (max 4) LED units

Optional features of Buzzer with dual sound mode-continuous & intermittent with 80 dB output

Different mounting options like Base mounted, L clamp, Wall mounted, Swiveling base

IP65 & NEMA (1 | 2 | 3 | 3R | 4 | 4X | 12 | 13)



Most Popular Combinations

Single Stack	Double Stack	Three Stack	Four Stack
Tower light without buzzer - 24 VAC/DC			
TW1UR1	TW1UR1G1	TW1UR1A1G1	TW1UR1G1A1B1
Tower light with Buzzer - 24 VAC/DC			
TW1UZ1	TW1UR2Z2	TW1UR1G1Z1	TW1UR1A1G1Z1
Tower light without Buzzer - 240 VAC			
TW1XR2	TW1XR1G1	TW1XR1A1G1	TW1XR1G1A1B1
Tower light with Buzzer - 240 VAC			
TW1XZ1	TW1XR1Z1	TW1XR1G1Z1	TW1XR1A1G1Z1



Selection Decoding

Description		Code
Tower Light		TW
Base	Small Base (SB)	1
	Big Base (BB)	2
Voltage	240V AC	X
	110V AC	W
	24V AC/DC	U
	12V AC/DC	T
Unit Colour	Red	R
	Green	G
	Yellow	Y
	Amber	A
	Blue	B
Luminous Mode	Continuous	1
	Blinking	2
	Revolving	3
Buzzer*	Continuous	Z1
	Intermittent	Z2

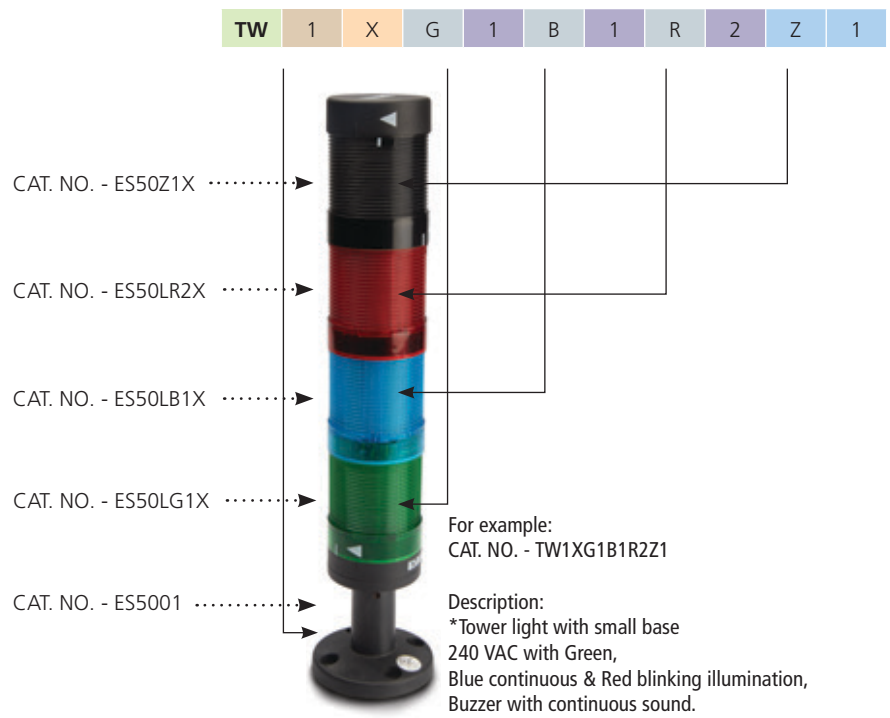

Tower Light Base Selection



Base Type	Base Height	Part code
Small	60 mm	ES5001
Big	110 mm	ES5002



Luminous Lens Selection



Tower Light Lens popular configuration				
Housing Colour	Voltage	Part code Luminous Mode		
		Continuous	Blinking	Revolving
●	012V AC/DC	ES50LR1T	ES50LR2T	ES50LR3T
	024V AC/DC	ES50LR1U	ES50LR2U	ES50LR3U
	110V AC	ES50LR1W	ES50LR2W	ES50LR3W
	240V AC	ES50LR1X	ES50LR2X	ES50LR3X
●	012V AC/DC	ES50LG1T	ES50LG2T	ES50LG3T
	024V AC/DC	ES50LG1U	ES50LG2U	ES50LG3U
	110V AC	ES50LG1W	ES50LG2W	ES50LG3W
	240V AC	ES50LG1X	ES50LG2X	ES50LG3X
●	012V AC/DC	ES50LB1T	ES50LB2T	ES50LB3T
	024V AC/DC	ES50LB1U	ES50LB2U	ES50LB3U
	110V AC	ES50LB1W	ES50LB2W	ES50LB3W
	240V AC	ES50LB1X	ES50LB2X	ES50LB3X
●	012V AC/DC	ES50LY1T	ES50LY2T	ES50LY3T
	024V AC/DC	ES50LY1U	ES50LY2U	ES50LY3U
	110V AC	ES50LY1W	ES50LY2W	ES50LY3W
	240V AC	ES50LY1X	ES50LY2X	ES50LY3X
●	012V AC/DC	ES50LA1T	ES50LA2T	ES50LA3T
	024V AC/DC	ES50LA1U	ES50LA2U	ES50LA3U
	110V AC	ES50LA1W	ES50LA2W	ES50LA3W
	240V AC	ES50LA1X	ES50LA2X	ES50LA3X
●	012V AC/DC	ES50LW1T	ES50LW2T	ES50LW3T
	024V AC/DC	ES50LW1U	ES50LW2U	ES50LW3U
	110V AC	ES50LW1W	ES50LW2W	ES50LW3W
	240V AC	ES50LW1X	ES50LW2X	ES50LW3X



Buzzer Lens Selection



Buzzer Colour	Voltage	Part code sound mode	
		Continuous	Intermittent
●	012V AC/DC	ES50Z1T	ES50Z2T
	024V AC/DC	ES50Z1U	ES50Z2U
	110V AC	ES50Z1W	ES50Z2W
	240V AC	ES50Z1X	ES50Z2X

Tower light with different Mountings



Accessories	Part Code
Base mounted	ES5019



Accessories	Part Code
Wall mounted bracket	ES122012A



Swiveling	
100 mm	ES60004
200 mm	ES60006
400 mm	ES60010
500 mm	ES60012
800 mm	ES60018
1000 mm	ES60022



L clamp	
100 mm	ES70004
200 mm	ES70007
400 mm	ES70010
500 mm	ES70012
800 mm	ES70018
1000 mm	ES70022

Note: Please refer page no. 65 & 66 for drawings and technical specifications



Limit Switches CE

Features

Rigid construction with metal body & plastic cover

Made in engineering plastic with high mechanical strength & heat sustenance capacity

Cable entry from bottom side with provision of cable gland PG 13.5/M20

Oil, water & dust proof

Mechanical life - 1 Million & Electrical life - 0.5 Million

Available in different actuators to suit different applications

SLPB Series



SLPBS3A1



SLPBS3F5



SLPBS3B2



SLPBS3B4



SLPBS3LP



SLPBS3EE



SLPBS3D



SLPBS3F7

Cat. No.	Housing & Entry	Contacts	Operating Head
SLPBS3A1	Plastic Housing Bottom Entry	1 No + 1 NC Snap Action	Top push rod plunger (TP 2MM)
SLPBS3F5			Adjustable plate roller side push lever Ø 18 X 6.2 MM
SLPBS3B2			Metal top roller push plunger
SLPBS3B4			Metal side roller centre actuation
SLPBS3LP			Flexible plastic rod
SLPBS3EE			Side rotary lever with steel roller
SLPBS3D			Metal roller with vertical actuation
SLPBS3F7			Adjustable offset rubber Ø 50 x 8MM roller lever

Note: Please refer page no. 67 for drawings and technical specifications

SLPS Series



SLPSS3A1



SLPSS3F6



SLPSS3B2



SLPSS3RM



SLPSS3LP



SLPSS3EE



SLPSS3D



SLPSS3F7

Cat. No.	Housing & Entry	Contacts	Operating Head
SLPSS3A1	Plastic Housing Side Entry	1 No + 1 NC Snap Action	Top push rod plunger
SLPSS3F6			Adjustable metal roller lever Ø 17.5X 7MM
SLPSS3B2			Metal top roller push plunger
SLPSS3RM			Reversible adjustable plastic lever metal roller
SLPSS3LP			Flexible plastic rod
SLPSS3EE			Side rotary lever steel roller
SLPSS3D			Metal roller vertical actuation
SLPSS3F7			Adjustable offset rubber Ø 50 x 8MM roller lever

Note: Please refer page no. 67 for drawings and technical specifications

SLMPB Series



SLMPBS3D1



SLMPBS3F5



SLMPBS3A1



SLMPBS3B3



SLMPBS3B2



SLMPBS3M3



SLMPBS3M4

Cat. No.	Housing & Entry	Contacts	Operating Head
SLMPBS3D1	Metal Housing & Plastic Cover Bottom Entry	1 No + 1 NC Snap Action	Plastic roller side push lever
SLMPBS3F5			Adjustable plastic roller side push lever 18x6.2
SLMPBS3A1			Top push rod plunger
SLMPBS3B3			Metal top roller 90° push plunger
SLMPBS3B2			Metal top roller push plunger
SLMPBS3M3			Side rotary adjustable metal rod
SLMPBS3M4			Flexible rod

Note: Please refer page no. 68 for drawings and technical specifications

SLMB Series



SLMB3D3



SLMB3A2



SLMB3F6



SLMB3F7



SLMB3A3



SLMB3C3



SLMB3B5



SLMB3C4

Cat. No.	Housing & Entry	Contacts	Operating Head
SLMB3D3	Metal Housing Bottom Entry	1 No + 1 NC Snap Action	Metal roller fixed side push lever
SLMB3A2			Big top push rod plunger
SLMB3F6			Adjustable metal roller lever Ø 17.5X 7MM
SLMB3F7			Adjustable offset rubber Ø50X8 MM roller lever
SLMB3A3			Top push metal rod
SLMB3C3			Metal roller with metal plunger
SLMB3B5			Double plastic roller side push plunger
SLMB3C4			Double metal roller side push plunger

Note: Please refer page no. 69 for drawings and technical specifications

SLMS Series



SLMSBS3B4

SLMSBS3E3

SLMSBS3A1

SLMSBS3F6

Cat. No.	Housing & Entry	Contacts	Operating Head
SLMSBS3B4	Metal Housing Side Entry	1 No + 1 NC Snap Action	Metal side roller center actuation
SLMSBS3E3			Rubber Ø50X10MM roller lever plunger
SLMSBS3A1			Top push rod plunger
SLMSBS3F6			Adjustable metal roller lever Ø 17.5X 7mm

MLAS



MLASS3A1

MLASS3B2

MLASS3C4

MLASS3C0

Cat. No.	Housing & Entry	Contacts	Operating Head
MLASS3A1	Plastic Housing Side Entry	1 No + 1 NC Snap Action	Top push rod plunger operating position 21.8 MM
MLASS3B2			Top roller push plunger operating position 33.3 MM
MLASS3C4			Fixed lever plastic roller operating position 40 MM
MLASS3C0			Centre push with no lever operating position 25 MM

Note: Please refer page no. 70 & 71 for drawings and technical specifications



MLPB Series



Cat. No.	Housing & Entry	Contacts	Operating Head
MLPBS3A2	Plastic Housing Bottom Entry	1 No + 1 NC Snap Action	Top push rod plunger operating position 21.5 MM
MLPBS3A3			Top push rod plunger operating position 21.8 MM
MLPBS3C2			Metal roller centre push lever operating position 33.4 MM
MLPBS3L3			Lever with operating position 19 MM
MLPBS3C1			Plastic roller centre push lever operating position 30.2 MM
MLPBS3L4			Diameter 1mm rod operating position 19 MM
MLPBS3E5			Angular movement plastic roller operating position 43.1 MM

Accessories for MLPB Series



CAP

Description	Cat. No.
PVC CAP	HB482000

Note: Please refer page no. 72 for drawings and technical specifications

MNPS Series



MNPS3100D



MNPS3101D



MNPS3103C



MNPS3100RD



MNPS3100GD

Cat. No.	Housing & Entry	Contacts	Operating Head
MNPS3100D	Plastic Housing Bottom Entry	1 No + 1 NC Snap Action	10A, button type with 187 terminal
MNPS3101D			10A, long handle type with 187 terminal
MNPS3103C			10A, long pulley type with 250 terminal
MNPS3100RD			10A, button type red head with 187 terminal
MNPS3100GD			10A, button type green head with 187 terminal

Note: Please refer page no. 73 for drawings and technical specifications



Elevator Products

Features

ABS engineering plastic material resistant to ageing, impact, corrosion & non conductive to heat unlike metal enclosure

Fire retardant

Robust & total maintenance free

IP65 Protection

Fully insulated to house electrical & electronic equipment w.r.t. protection against electric shock

Temperature Resistance from -20°C to 70°C

Pit Switches

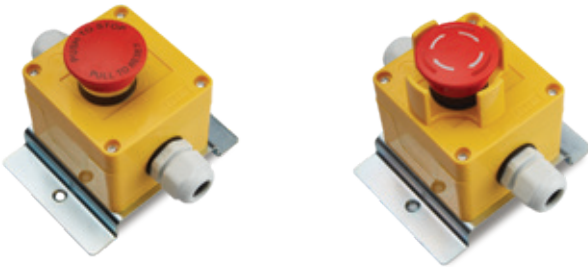

Part No.	Type of Switch	Type of Contact	No's of Contact	Cable Gland	Qty. of Cable Gland	Protecting Shroud	Mounting Bracket
JMJB0000	Mushroom Head Push Pull	NC	1	PG 13.5	2	NA	MS Yellow Passivation
JJJE0000	Mushroom Head Push Pull	NC	2	PG 13.5	1	NA	MS Yellow Passivation
JLFB0000	Mushroom Head Push Turn	NC	1	PG 13.5	2	1	MS Yellow Passivation
JKFE0000	Mushroom Head Push Turn	NC	2	PG 13.5	1	1	NA
JKFB0000	Mushroom Head Push Turn	NC	1	NA	NA	1	NA
JQFB0000	Mushroom Head Push Turn	NC	1	PG 13.5	1	1	NA

Car Top Box



Features

Wall mounted

Available with Cam Switch

4 Way Push Button Station

Cat. No. EJ4C3AN028

Note: Please refer page no. 76 for drawings and technical specifications

Customized Solutions - Car top box



EWS5C13BT91

EWS3C13BU93

EWS3C13BV94

EWS2C13AG95

EWS1C13AA96

EWS1C13BW97

Note: For your customized / special requirement of car top box please contact our sales team.

LED Solutions

Features

Customized solution for different elevator applications

Low power consumption

LED's with long life of close to 0.1 million continuous burning hrs

Passes surge test 2kV & HV test of 1.5kV

Low power consumption

-20°C to 70°C

LED Torch



LED Torch with Hook



High Illumination LED Torch



	LED Torch without Hook	LED Torch with Hook	High Illumination LED Torch
Cat. No.	IL24L55	IL24L40	IL16N42W240A
Colour (8 th Digit)	W - White		
Voltage (9 th , 10 th , 11 th & 12 th Digit)	024 C - 24V AC/DC		
	110 A - 110 V AC		
	240 A - 240 V AC		

Note: Please refer page no. 74 for drawings and technical specifications



Car Light



Car Light	
Cat. No.	IL07K27W240A

LED with Magnet



LED with Magnet	
Voltage	Cat. No.
240V AC	IL06A00W240A
110V AC	IL06A00W110A

Emergency lighting



8 LED Strip



12 LED Strip

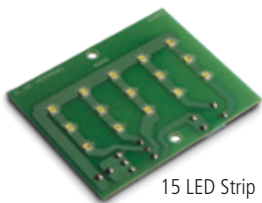

15 LED Strip

Product	Cat. No.	Color	Voltage
8 LED Strip	LT00G08	White	12 V DC
12 LED Strip	IL12A05W012D	White	12 V DC
15 LED Strip	IL15B13W012D	White	12 V DC
3 LED	IL03N39W012D	White	12 V DC

Note: Also available in 24V DC/6V DC

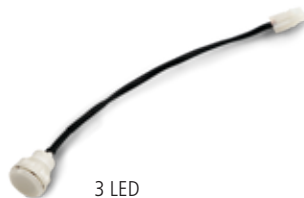

3 LED

Note: Please refer page no. 75 & 76 for drawings and technical specifications



Accessories

Gen Next Series





Gen Next First Row Clip

Cat. No. HC922003



Protecting Shroud for Gen Next Selector Actuator

Color	Cat. No.
	HF192025
	HF192413

Common Accessories



Protecting Shroud

Cat. No. HF195004



Protecting Shroud for Selector Actuator

Cat. No. HB105006



Yellow legend plate

Cat. No. HB135000



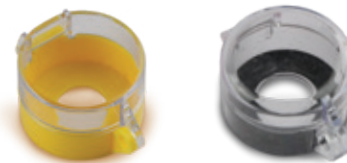

Collar (For Flush/Projecting Head)

Colour	Standard Series	Gen Next Series
	Cat. No.	Cat. No.
Chrome Plated 'ABS'	HB192000	HB192006
Black 'ABS'	HB196000	HB192003
'Brass'	HB326000	HB192002



Padlock for Emergency Push Buttons

Color	Cat. No.
	HF192024
	HF192025



Protecting Shroud for Gen Next Emergency

Cat. No. HF195018A



Adaptor Ring (For 30 to 22mm in Panel Cutout Conversion)	
Color	Cat. No.
Gray	HH180000
Black 'ABS'	HH196006



Center indication Strip (For Twin Touch Actuator)	
Color	Cat. No.
●	HB102058
●	HB105163
●	HB108169
○	HB100161



Blanking Plugs	
Color	Cat. No.
Grey	HH1820002
Black 'ABS'	HH182009
Chrome Plated 'ABS'	HH196010



Fixing Device	
Cat. No.	HH192000



Metal Plates - Spare	
Cat. No.	HH2420124

Note: Different Printing Available



Spare Lens Cap for Flush Head Non Illuminated Actuators	
Color	Cat. No.
●	HB103002
●	HB104000
●	HB102006
●	HB105008
●	HB101004
●	HB107010
●	HB108012



Rubber Shroud for Stand- ard Actuator	
Color	Cat. No.
●	HH152002
●	HH153003
●	HH154004
●	HH155005
○	HH150100



Rubber Shroud For Gen Next Actuators	
Color	Cat. No.
●	HB17101
●	HB17301
●	HB17401
●	HB17501
●	HB17701
●	HB17801
○	HB190003

Cable Tie Holder



Cable Tie Holder	
Cat. No.	CTHC3797
Length of Screw Body	37 mm
Cable Entry Width L	9.7 mm

Cable Tie



Cable Tie				
Cat. No.	CTC030072	CTC025072	CTC020072	CTC015072
Length	300 mm	250 mm	200 mm	150 mm
Width	7.2 mm	7.2 mm	7.2 mm	7.2 mm

Cable Gland



Cable Gland	
Cat. No.	CG□□□□
Color (3 rd Digit)	●
	●
Size (4 th , 5 th & 6 th Digit)	009-PG9
	011-PG11
	013-PG13.5
	016-PG16
	018-PG18
	021-PG21



Technical Specifications

Pro Led Indicators 

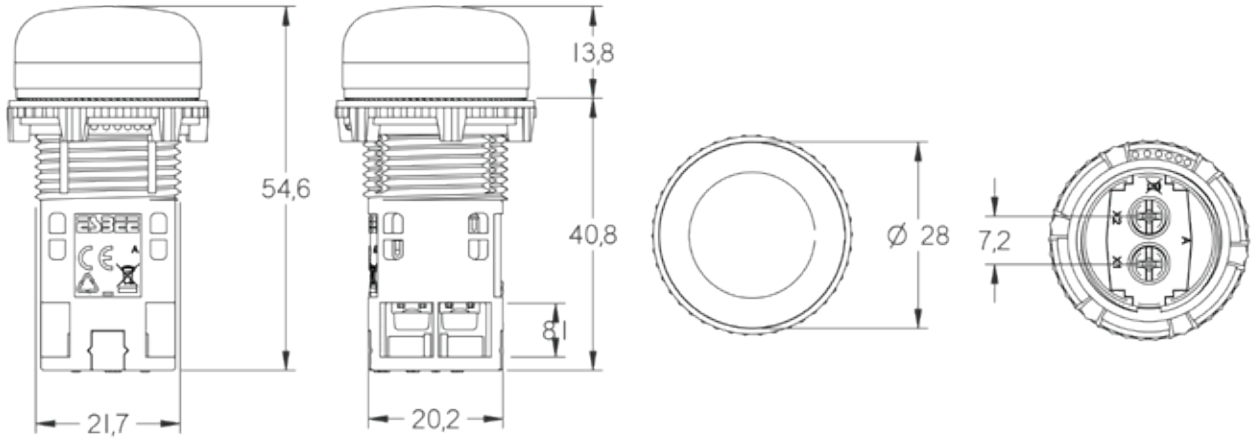

Test Parameters	Specification
Product	Pro LED Indicator
Rated Voltage	12V AC/DC, 24V AC/DC, 30V AC/DC, 48V AC/DC, 64 V AC/DC, 110 VAC, 110VDC, 240 VAC, 220VDC, 415VAC
Operating Voltage	-20% to +10% of rated voltage
Type of LED	SMD LED
Available Colours	Red / Green / Blue / Yellow / Amber / White / Clear
Life / Warranty	0.05 Million burning hours/36 Months*
Operating Frequency	50/60 Hz
Operating Temperature	-25°C to 65°C
Storage Temperature	-30°C to 70°C
Wire Termination Capacity	0.5 mm ² , 1.5 mm ² - 2.5 mm ²
LED Arrangement	Cluster Type
Terminal Torque	1 Nm
LVGP	Available
Surge Test	2KV
Hv Test for 60 sec.	2.5KV
Degree of Protection	Above Panel: IP65 For Terminals: IP20
International Approvals	CE

* To be used in standard environmental conditions.



Gen Next Led Indicators & Universal Led Indicators

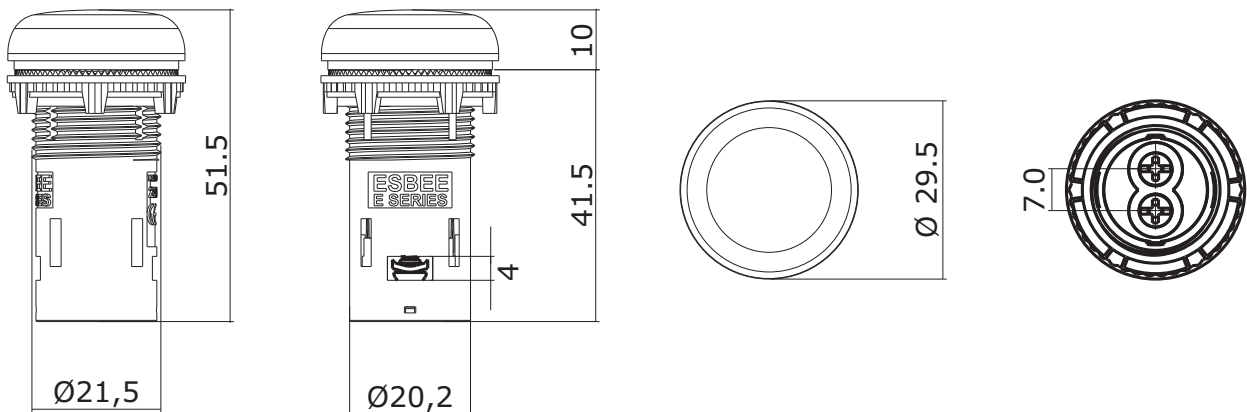

Test Parameters	Specification	Specification
Product	22.5 mm Gen Next LED Indicators	Universal LED Indicator (Barrel Type)
Rated Voltage	12V AC/DC, 24V AC/DC, 30V AC/DC, 48V AC/DC, 64V AC/DC, 110 VAC, 110 V DC 240 VAC, 220V DC 415V AC	24V-240V AC/DC 40V-240V AC/DC
Operating Voltage	-20% to +10% of rated voltage	-10% to +10% of rated voltage
Rated Current	10-30mA	02 to 10 mA
LED's	SMD LED	SMD LED
Power Consumption	< 1W	< 1W
Colours Available	Red / Green / Yellow / Amber / Blue / White / Clear	Red / Green / Blue / Yellow / Amber / White / Clear
Life / Warranty	0.05 Million burning hours/36 Months*	0.05 Million burning hours/36 Months*
Operating Temperature	-25°C to 65°C	-25°C to 60°C
Storage Temperature	-30°C to 70°C	-30°C to 65°C
Hv Test for 60 sec.	1.5 KV	1.5 KV
Degree Of Protection	Above Panel: IP65 For Terminals: IP20	Above Panel: IP65 For Terminals: IP20
Low Voltage Glow Protection	2kV	NA
Wire Termination capacity	0.5 mm ² , 1.5 - 2.5 mm ²	0.5 mm ² , 1.5 - 2.5 mm ²
Terminal Torque	0.8 Nm	0.8 Nm
No. of LED's	2	2
International Approval	CE, UL	CE, UL

* To be used in standard environmental conditions.



16 mm Gen Next LED Indicators & 10 mm Led Indicators

16 mm Indicator

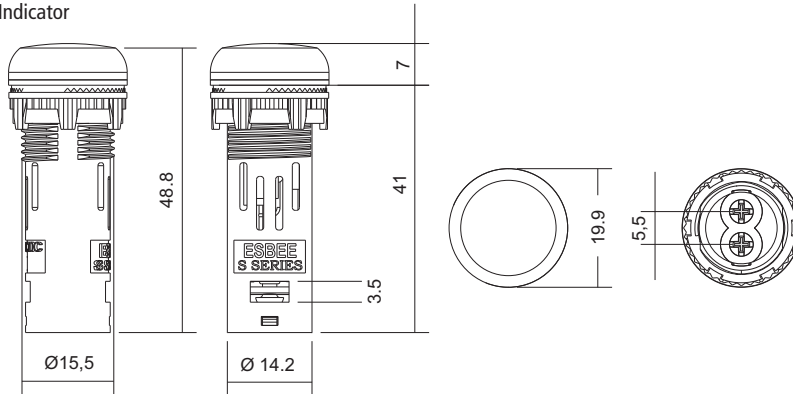

10 mm Indicator

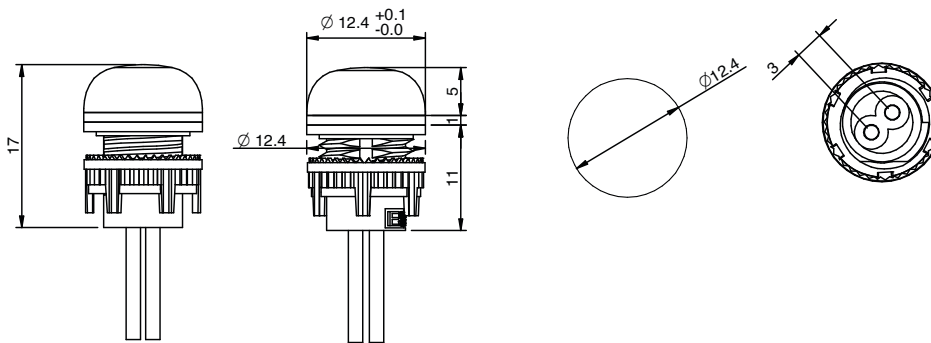

Test Parameters	Specification	Specification
Product	16 mm Gen Next LED Indicators	10 mm Indicators
Rated Voltage	12V AC/DC, 24V AC/DC, 30V AC/DC, 48V AC/DC, 64V AC/DC, 110V AC/DC, 240V AC	5V DC, 24V DC
Operating Voltage	-20% to +10% of rated voltage	-20% to +10% of rated voltage
Type of LED	SMD LED	SMD LED
Available Colours	Red / Green / Yellow / Amber / Blue / White	Red / Green / Yellow / Amber / Blue / White
Life / Warranty	0.05 Million burning hours/36 month*	0.01 Million burning hours/36 month*
Operating Frequency	50 / 60 Hz	50 / 60 Hz
Operating Temperature	-25°C to 65°C	-25°C to 65°C
Storage Temperature	-30°C to 70°C	-30°C to 70°C
Wire Termination Capacity	0.5 mm ² , 1.5 mm ²	NA
Terminal Torque	0.8 Nm	NA
LVGP	Available	NA
Surge Test	2kV	NA
HV test for 60 sec.	1.5kV	1.5kV
Degree of Protection	Above panel: IP65 For terminals: IP20	Above panel: IP65 For terminals: IP20
LED Arrangement	Cluster Type	NA
International Approvals	CE, UL	NA

* To be used in standard environmental conditions.



Panel Mounted Buzzer

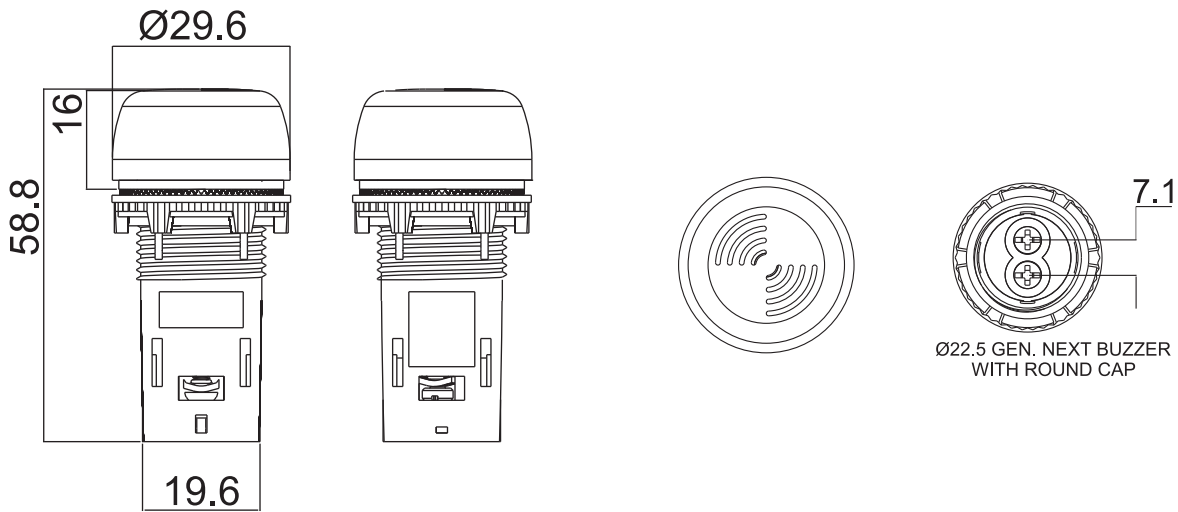

Test Parameters	Specification
Product	Panel Mounted Buzzer
Rated Voltage	12V AC/DC, 24V AC/DC, 30V AC/DC, 48V AC/DC, 63.5V AC/DC, 110V AC, 240V AC
Operating Voltage	-20% to + 10% of rated voltage
SPL (Sound Pressure Level)	>80dB
Colour	Black
Life / Warranty	>0.01 Million burning hours/24 months*
Operating Frequency	50/60 Hz
Operating Temperature	-25°C to 65°C
Storage Temperature	-30°C to 70°C
Wire Termination Capacity	Min. 0.5 mm ² , 1.5 - 2.5 mm ²
Terminal Torque	0.8 Nm
Surge Test	2kV
Hv Test for 60 sec.	2.5kV
Degree of Protection	Above Panel: IP55 For Terminal: IP20
International Approval	CE, UL

* To be used in standard environmental conditions.



Gen Next Modular Push Button-Illuminated

Flush Head Actuator

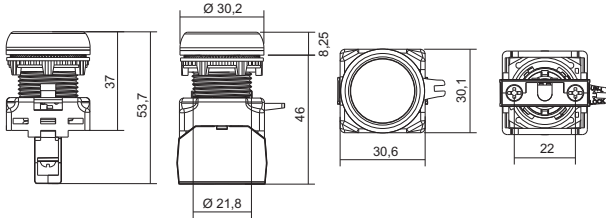

Projecting Head Push Function Actuator

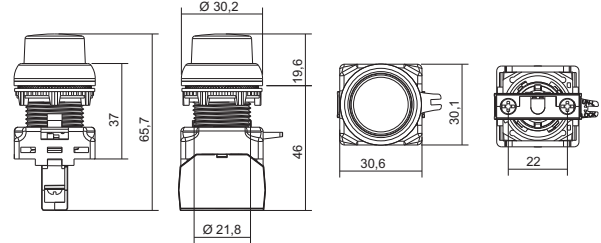

Twin-Touch Actuator

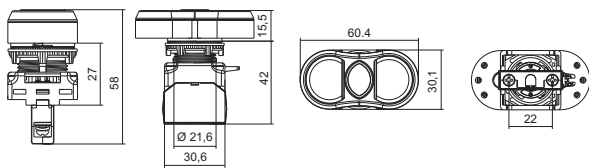

Selector Actuator

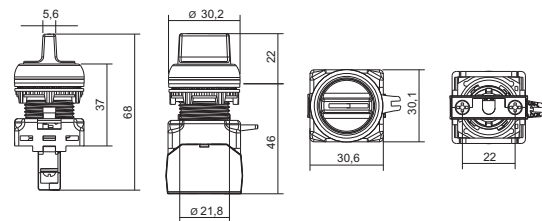

LED Holder

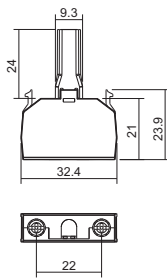

Test Parameters	Specification
Product	Gen Next LED Actuators
Rated Voltage	12 V AC/DC, 24 V AC/DC, 30 V AC/DC, 48 V AC/DC, 64 V AC/DC, 110 V AC, 110 V DC, 240 V AC, 220V DC
Operating Voltage	-20% to +10% of rated voltage
Type of LED	Side View SMD LED's
Available Colours	Red / Green / Yellow / Amber / Blue / White
Life / Warranty	0.1 Million burning hours/24 Months**
Operating Frequency	50 / 60 Hz
Operating Temperature	-25°C to 65°C
Storage Temperature	-30°C to 70°C
Wire Termination Capacity	0.5 mm ² , 1.5 - 2.5 mm ²
Terminal Torque	0.8 Nm
LVGP	Available
Surge Test	2KV
HV test for 60 sec.	1.5KV
Degree of Protection	Above Panel: IP65 For Terminals: IP20
International Approvals	CE, UL

**To be used only with Gen Next Contact Blocks & Gen Next LED holder.

Gen Next Modular Push Button- Non-Illuminated

Flush Head Actuator

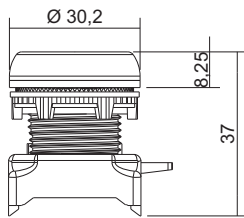

Projecting Head Push Function Actuator

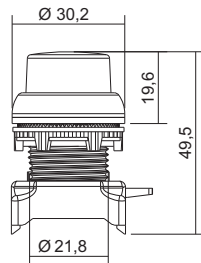

Gen Next Pro Push Turn

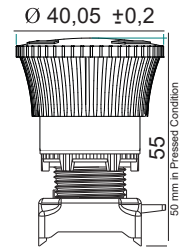

Mushroom Head Push - Function Actuator

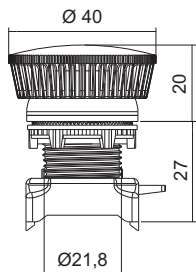

Mushroom Head Push - Turn with Indication

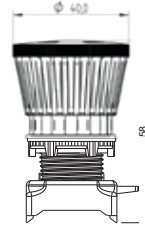

Mushroom Head Push - Pull with Indication

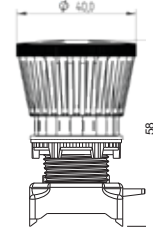

Mushroom Head Push - Pull Actuator

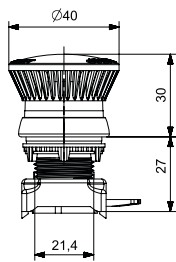

Mushroom Head Lock & Key Actuator

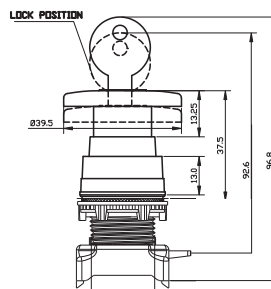

Illuminated Legend Plate

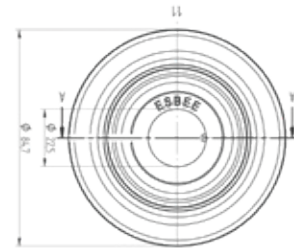

Twin-Touch Actuator

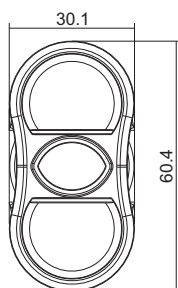

Selector Actuator

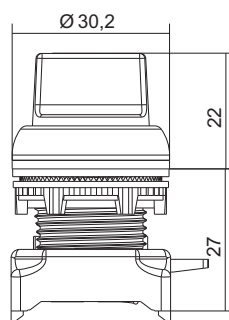

Lever Head Actuator

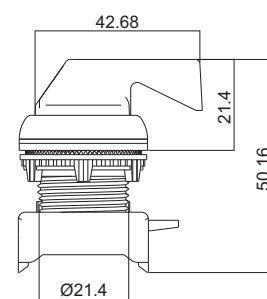



Lock & Key Rotary Actuator

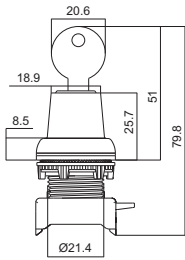

Gen Next Contact Blocks

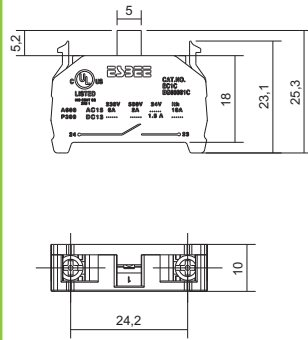

Cage Clamp Contact Blocks

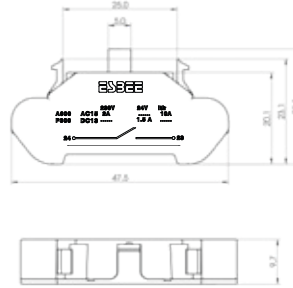

PCB Mounted Contact Blocks

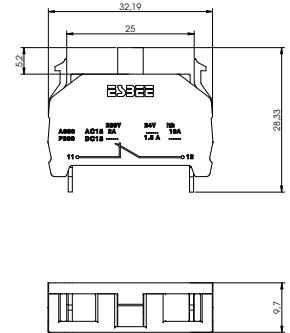

Test Parameters	Specification			
	Supply	IEC - 60947-5-1	UL-508	ITH/Thermal Current
Utilization Category	AC	AC-15	A600	10A
	DC	DC-13	P300	
Contact	NO and NC			
Rated Voltage	230V AC	120V AC	24V DC	
Rated Current	6A	6A	1.5A	
Frequency	50 - 60 Hz			
Electrical Life for Contact / Warranty	1 Million cycle/24 Months**			
HV Test for 60 Sec.	2.5KV (All Terminals Shorted Together)			
Rated Insulation Voltage	600 VAC			
Terminals	Suitable for flexible or solid conductors from 2x1 mm ² to 2x2.5 mm ²			
Current Carrying Material	Brass			
Contact Type	Make & Break			
Contact Material	AgNi			
Insulation Resistance at 500 VDC	50 mΩ			
Operating Torque	0.8 Nm			
Contact Resistance	20 mΩ			
mV drop at 16 A DC	200 mV			
Type	Non Illuminated / Illuminated			
Function	Push, Push - Push, Push turn, Selector			
Colour	Red / Green / Black / Yellow / White / Blue / Orange			
Disposition of Contact	<div style="display: flex; align-items: center;"> <div style="margin-right: 10px;"> <input type="checkbox"/> Contact Open <input checked="" type="checkbox"/> Contact Close </div> <div style="margin-right: 10px;"> NC NO </div> <div style="margin-right: 10px;"> </div> </div>			
International Approvals	CE, UL			

**To be used only with Gen Next Contact Blocks & Gen Next LED holder



Environmental Rating	
Operating Temperature	-25°C to 65°C
Storage Temperature	-30°C to 70°C
IP Rating	IP65 above panel (As per IEC/EN -60529) & IP20 for Terminals NEMA 1,2,3,4,4X class 12 & 13
RoHS Compliance	Yes
Mechanical Life for Actuators	
Momentary (Push Button with Push Function)	1 million Operation
Emergency Stop (Turn to Release)	0.1 million Operation
Emergency Stop (Push Pull Type)	0.5 million Operation
Selector	0.5 million Operation



Gen Next Entegral Push Buttons

Flush Head Actuator

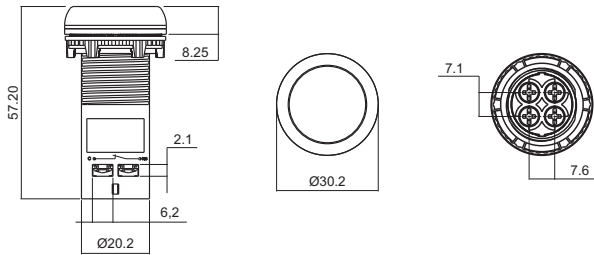

Projecting Head Push Function Actuator

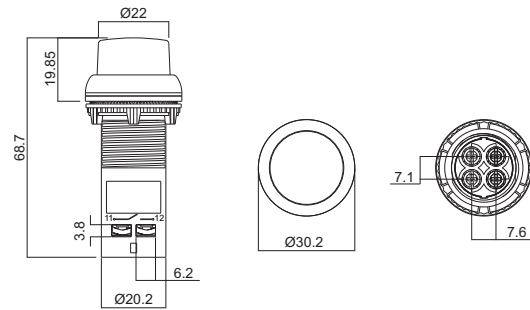

Mushroom Head Push Turn

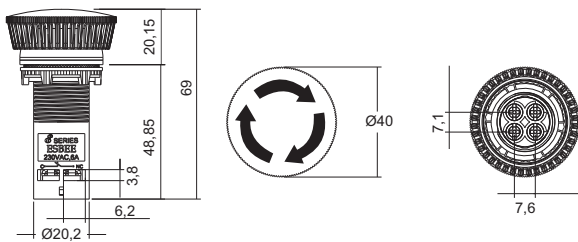

Mushroom Head Push Function

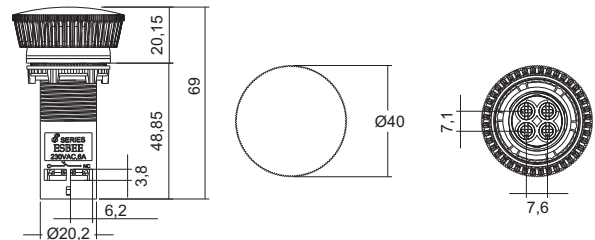

Symmetric Head

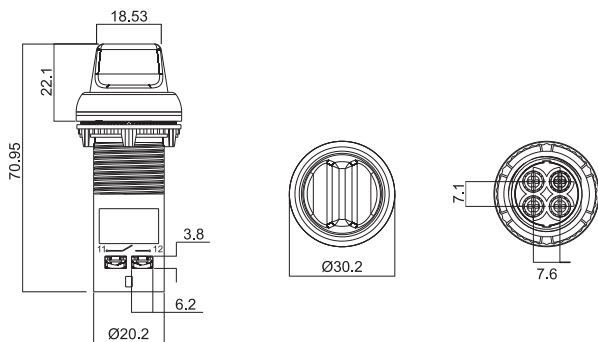

Lever Head

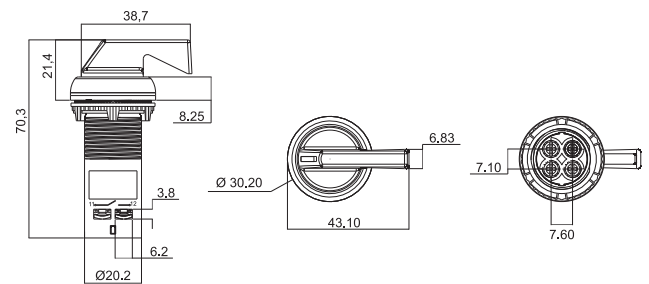



Lock and Key

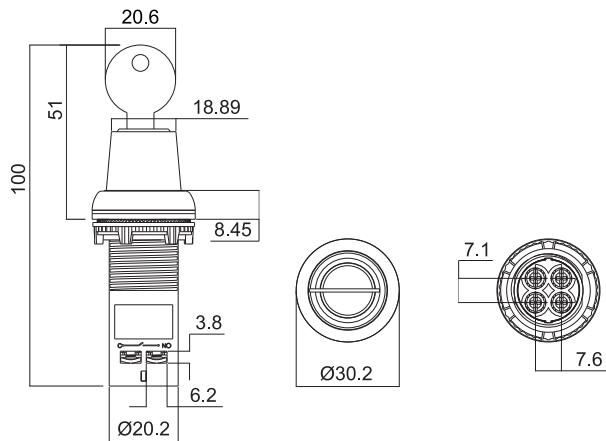

Test Parameters	Specification			
	Supply	IEC - 60947 - 5-1	UL - 508	ITH/Thermal Current
Utilization Category	AC	AC-15	A600	10A
	DC	DC-13	P300	
Contact	NO and NC			
Rated Voltage	230V AC	120V AC	24V DC	
Rated Current	6A	6A	1.5A	
Frequency	50 - 60 Hz			
Electrical Life for Contact / Warranty	1 Million Cycle/24 Months*			
HV Test for 60 Sec.	2.5KV (All Terminals Shorted Together)			
Rated Insulation Voltage	600 VAC			
Terminals	Suitable for flexible or solid conductors from 2x1 mm ² to 2x2.5 mm ²			
Current Carrying Material	Brass			
Contact Type	Make & Break			
Contact Material	AgNi			
Insulation Resistance at 500 VDC	50 mΩ			
Operating Torque	0.8 Nm			
Contact Resistance	20 mΩ			
mV drop at 16 A DC	200 mV			
Type	Non Illuminated			
Function	Push, Push - Push, Push turn, Selector			
Colour	Red / Green / Black / Yellow / White / Blue / Amber			
Disposition of Contact	<input type="checkbox"/> Contact Open <input checked="" type="checkbox"/> Contact Close			
International Approval	IEC, UL, NEMA 1, 2, 3R			

* To be used in standard environmental conditions.



Pro Push Button Station & Gen Next Push Button Stations

Single Station

Two Position Lock & Key Rotary Switch

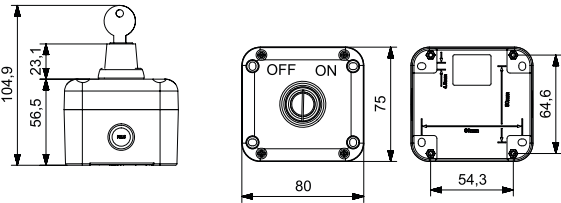

Flush Head Actuator

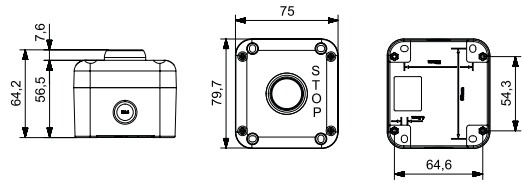

Two Position Symmetric Head Selector Switch

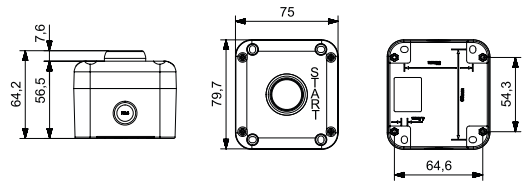
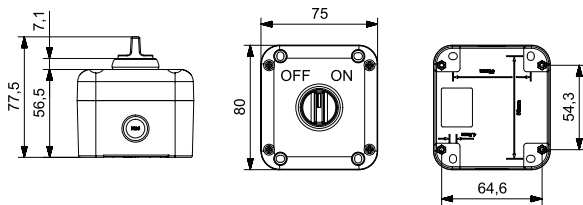

Mushroom Head Actuator 'Push Turn Type'

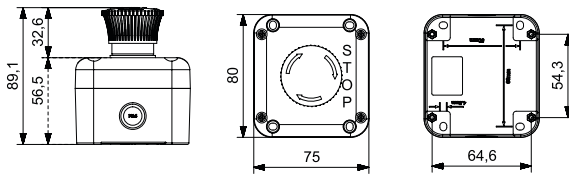

Mushroom Head Push Pull

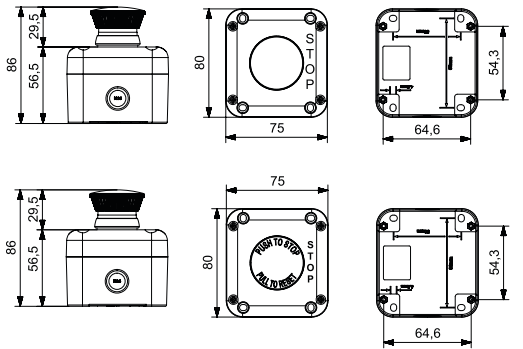

Mushroom Head Actuator Push Type

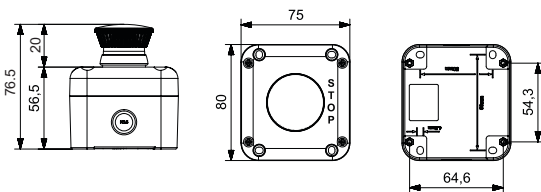

Mushroom Head Lock & Key Actuator

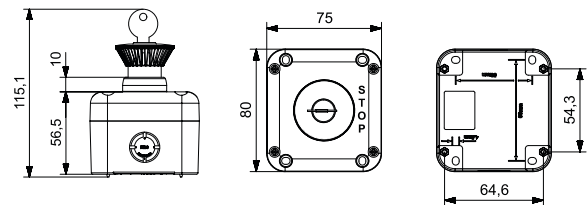



Two Station

Flush Head Actuator/Mushroom Head Actuator Push Turn Type

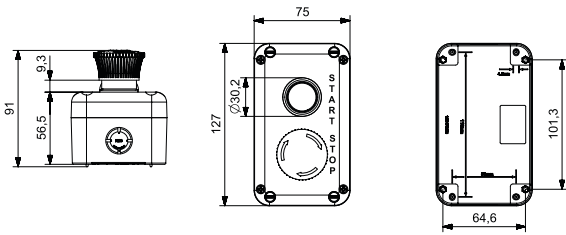

Flush Head Actuator/ Mushroom Head Lock & Key Actuator

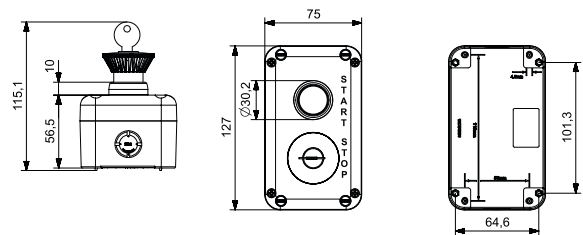

Flush Head Actuator

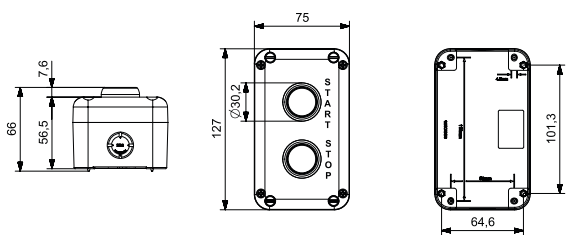

Three Station

LED Indicator 240V AC/ Flush Head Actuator

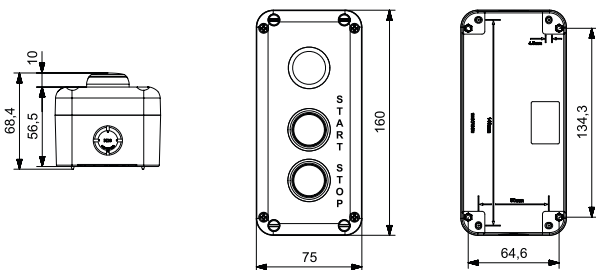

Flush Head Actuator

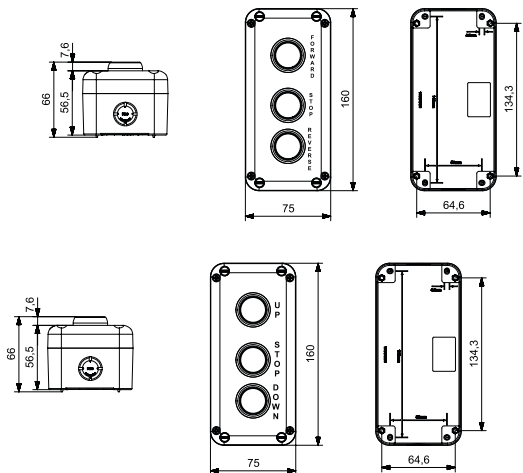

Enclosures

Four Station

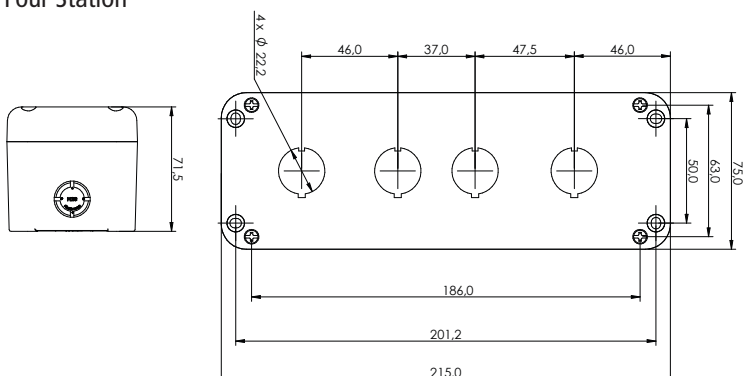



Five Station

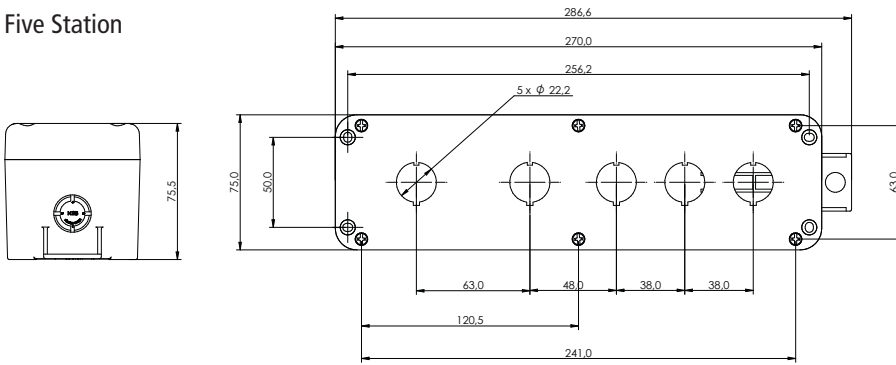

Gen Next Push Button Stations

Single Station

Flush Head Actuator

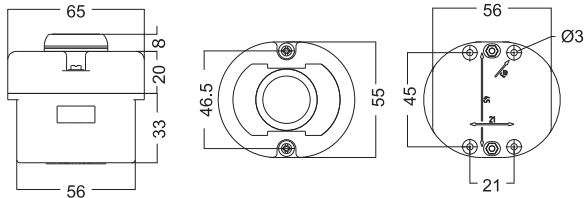

Two Position Symmetric Head

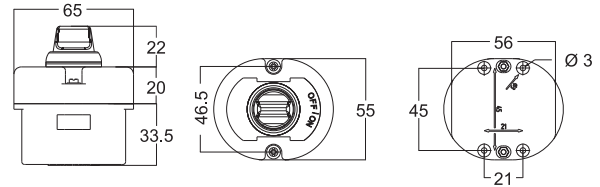

Two Position Lock & Key

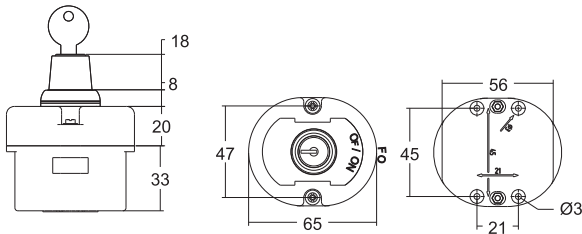

Mushroom Head Actuator (Push Function)

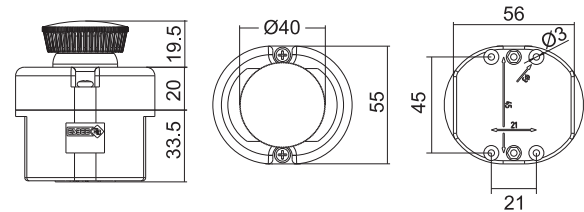

Mushroom Head Actuator (Push Turn Type)

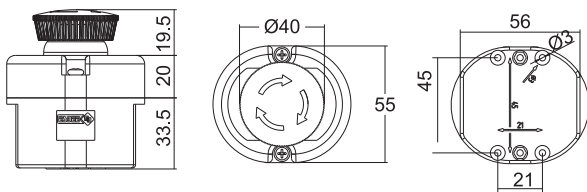

Two Station

Flush Head Actuator

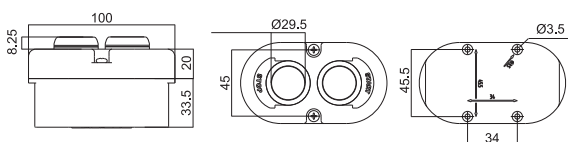

Mushroom Head Actuator (Push Function)

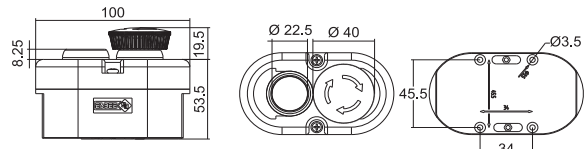



Three Station

LED Indicator 240V AC Flush Head Actuator

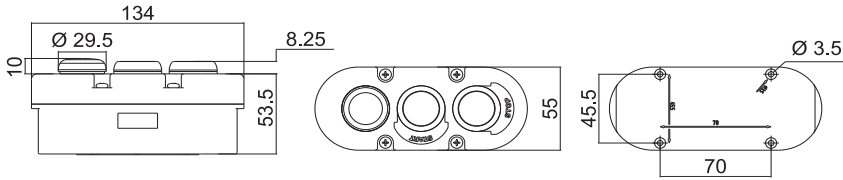

Flush Head Actuator

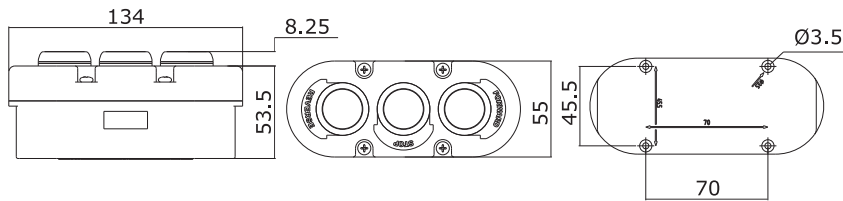

Flush Head Actuator

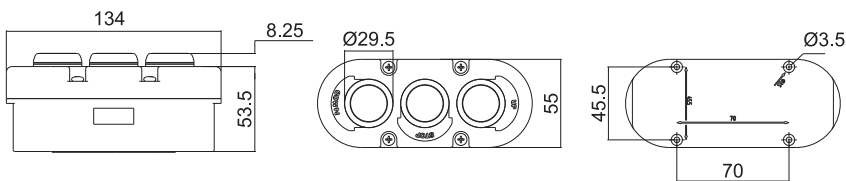

Eight Station

All 7 Flush Head Actuators with NO contact & Mushroom Head Push Turn with NC contact

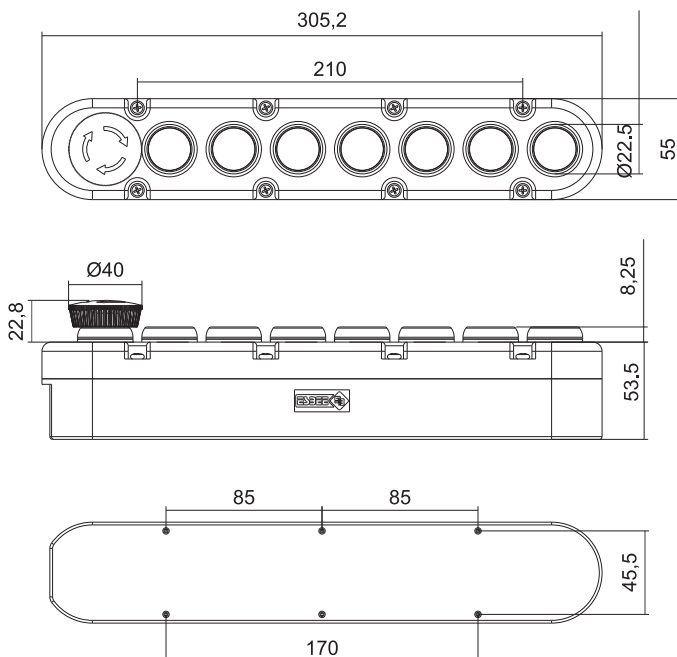



All 7 Flush Head Actuators with NO contact & Mushroom Head Push Turn with NC contact (with provision for hanging)

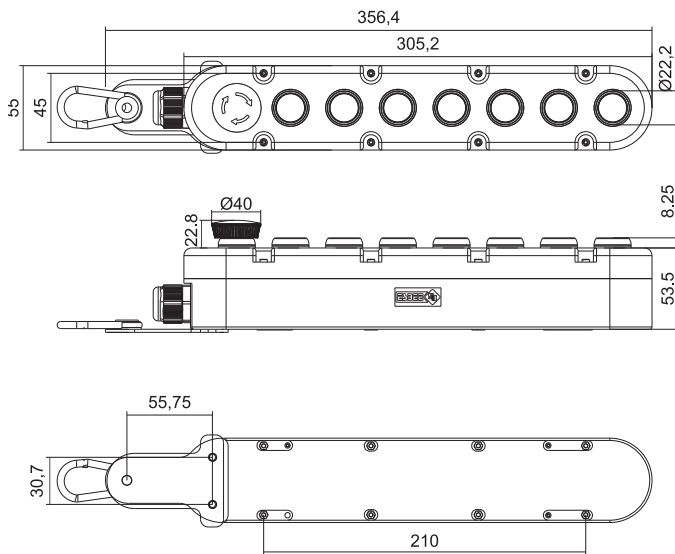

Test Parameters	Specification	Specification
Product	Gen Next Push Button Stations	Pro Push Button Stations
Degree of Protection	IP 65	IP 65
Safety	Fully insulated to hose electrical & electronic equipment w.r.t. protection against electric shock.	
Material	Bottom Cover: Tough, Impact resistant & fire retardant ABS. Top Cover: Tough, Impact resistant & fire retardant ABS. Gasket: Nitrile rubber, which is good resistant to Oil & acids. Screws: Half threaded Self tapping Cold Forged Screws with blacodising.	
Dimensions in mm (Length, Width, Depth)		
Single	65x55x33	75 x 75 x 56
Two	100x55x53	127 x 75 x 56
Three	134x55x53	160 x 75 x 56
Four	NA	215 x 75 x 70
Five	NA	270 x 75 x 71
Eight	305x55x53	NA
Screw Size for Wall Mounting	M3.5 mm Insertion of screws directly through base cover.	M4 mm Insertion of screws directly through base cover.
Maintenance	Do not need any particular maintenance. If necessary soap and water can be used for cleaning. If detergent is used, enclosure should be rinsed with clean water. Do not use any solvents to clean the enclosures.	
Temperature Range	Long term exposure to temperatures above 70° C should be avoided. No significant change in impact strength is noticed up to -20° C.	



Led Tube Light

Mushroom shaped tube light

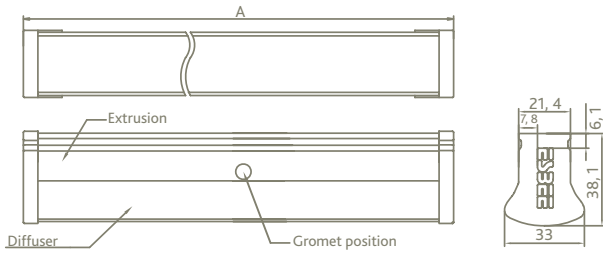

Square shaped tube light

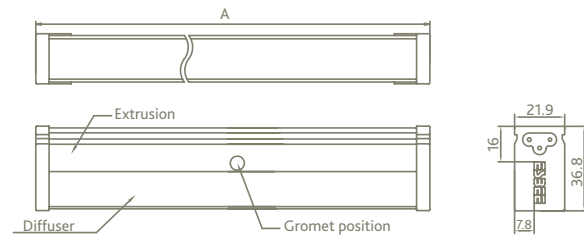

150 mm

Test parameters	Specification
Rated voltage	240V AC, 110V AC, 024V AC/ DC
Power consumption (240V)	< 3 W +/- 0.5W
Limit of operating voltage	-20% to +10% of rated voltage
Colour temperature	2500°K - 6500°K based on requirement
CRI	Ra = 87
Lumens	248
Operating temperature	-30°C to 65°C
Storage temperature	-30°C to 70°C
Surge protection	2 KV
Over Voltage Protection	340V (2 Hrs. working)

2 Feet

Test parameters	Specification
Input Voltage AC @50-60Hz	150 - 310V Ac
Input Power (W)	12
Power Factor	0.9
Product Life (Hrs.)	25,000 - 30,000***
Efficiency %	≥ 85
Depreciation	20% max after 50,000 hrs
Colour Temperature	2500°K - 6500°K based on requirement
CRI	Ra = 87
Lumens	990*
Over Voltage Protection	340V (2hrs working)
Surge Protection	2KV (L-L)
General Requirements and Safety	En61347 - 2 - 13
Operating Ambient Temp. Range (TA)	0 - 50°C
Maximum Operating Case Temp. (TC)	75°C
Housing Material	Aluminum + PC cap + End cap
Input Connection	2 Core 0.75mm sq wire (Red + Black)
Type	Square / Gen next

1 Foot

Test parameters	Specification
Input voltage AC @50-60Hz	150 - 310V AC
Input Power (W)	9
Power Factor	0.9
Product Life (hrs)	25,000 - 30,000***
Efficiency %	≥ 85
Depreciation	20% max after 50,000 hrs
Colour Temperature	2500°K - 6500°K based on requirement
CRI	Ra = 87
Lumens	750*
Over Voltage Protection	340V (2 Hrs. working)
Surge Protection	2KV (L-L)
General Requirements and Safety	En61347 - 2 - 13
Operating ambient temp. Range	0 - 50°C
Maximum Operating Case Temp.	75°C
Housing Material	Aluminum + PC cap + End cap
Input Connection	2 Core 0.75mm sq wire (Red + Black)
Type	Square/Gen next

***LED life is standard test condition.

*Lumens measured for all variant in standard test condition.



4 Feet

Test parameters	Specification
Input voltage AC @50-60Hz	150 - 310 v Ac
Input power (W)	16
Power factor	0.9
Product life (hrs)	25,000 - 30,000***
Efficiency %	≥ 85
Depreciation	20% max after 50,000 hrs
Colour temperature	2500°K - 6500°K based on requirement
CRI	Ra = 87
Lumens	1650*
Over voltage protection	340V (2hrs working)
Surge protection	2KV (L-L)
General requirements and safety	En61347 - 2 - 13
Operating ambient temp. range	0 - 50°C
Maximum operating case temp.	75°C
Housing material	Aluminum + PC cap + End cap
Input connection	2 core 0.75mm sq wire (Red + Black)
Type	Square/Gen next

Led Panel Lights

LED Panel Light with Bracket

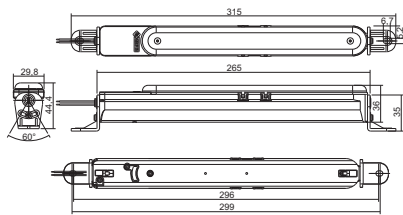

LED Panel Light with Magnet

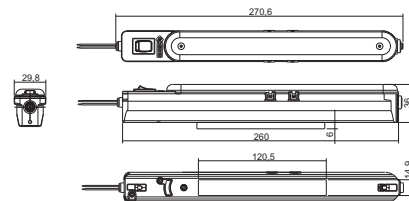

Test parameters	Specification
Rated Voltage	240V AC, 110V AC, 24V AC/DC, 12V DC
Limit of Operating Voltage	-20% to +10% of Rated Voltage
LED's	5 mm Th. Hole LEDs
Colours Available	White / Black / Grey
Life (Million burning hours)	0.1
LED Arrangement	Cluster
Colour Temp.	6000° K - 7000°K
No. of LEDs	24
Operating Frequency	50 / 60 Hz
Operating Temperature	-25° C to 65° C
Storage Temperature	-30° C to 70° C
Surge Test	4kV
HV Test for 60 sec.	2.5kV
EMI / EMC Protection	4kKV
IP Protection	IP 54
Power Consumption (240V AC)	<3W
Mounting & Centre Distance	Magnet, Screw M5 X 25, CD : 299mm
Housing	ABS
Lens Polycarbonate	Clear
Length x Width x Height	315 x 30 x 45 mm
Feature	Swivel/Magnet/Cascading
Lux @1 meter	90
International Approval	CE



Siren Flasher

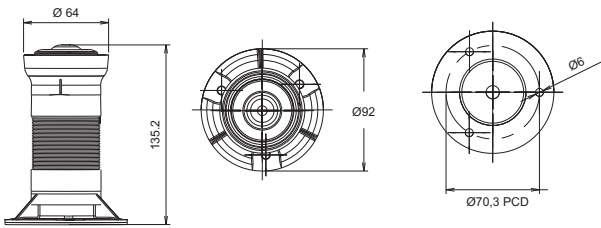

Test parameters	Specification
Rated Voltage	24V DC, 110V AC, 240V AC
Limit of Operating Voltage	-15% to +10% of rated voltage
Type of Sound	Single tone, Wail and Yelp signals with cycles 150-250/min
LED Flasher	Red Colour
Light Intensity	100 LUX
LED Life / Warranty	0.1 Million burning hours/24 Months*
Sound Output	100 dB
Surge	2 kV
EMI-EMC	2 kV
Operating Temperature	-25°C to +65°C
Storage Temperature	-30°C to +70°C
Degree of Protection	IP 65
Power Consumption	<5W
Polarity Protection	Provided
Insulation Resistance	1Ω
Contact Terminal	Red & Black Wire with L=50mm (Change as per customer req.)
International Approval	CE

Dimensional Details

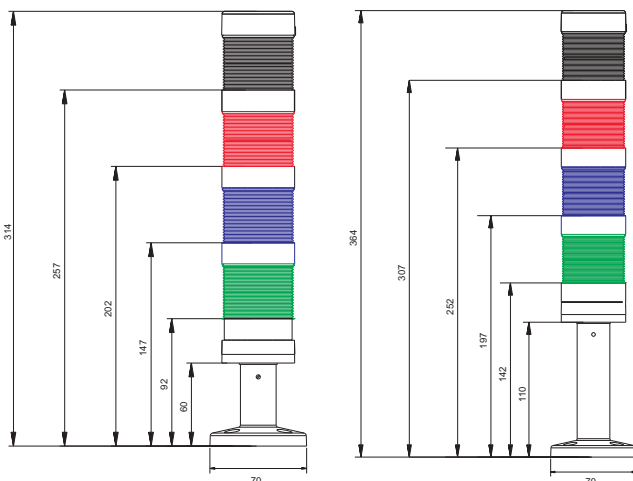

Tower Lights

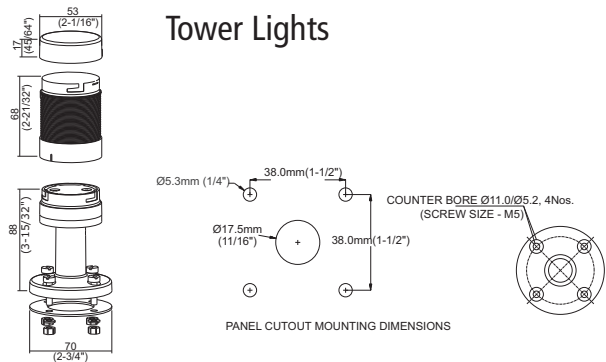

Test parameters	Specification
Outer Diameter	Ø50mm
Degree of Protection	IP65 & NEMA (1 2 3 3R 4 4X 12 13)
Led Type	SMD
Lens Colour	Red / Green / Amber / Blue / White / Yellow
Luminous Mode	Continuous, Blinking & Revolving
Led Life / Warranty	0.1 Million burning hours/24 Months*
Buzzer Colour	Black
Buzzer Sound Level	80dB ± 5dB at 1 meter
Sounding Mode	Continuous & Intermittent
Voltage Range	12V AC/DC, 24V AC/DC, 110V AC, 240V AC
Limit of Operating Voltage	±10% of rated voltage
Operating Frequency	50 / 60 Hz
Operating Temperature	-25°C to 65°C
Storage Temperature	-30°C to 70°C
Operating Torque	0.8 Nm
Wire Terminals	Wire size (AWG) 20-16 / 0.5 mm ²
Flash Rate (Time / Min)	±5% 60
Surge Test	2 KV
HV Test for 60 Sec.	1.5 KV
Current Rating	40-60mA for 12V AC/DC & 24V AC/DC 10-20mA for 110V AC & 240V AC
International Approval	CE, UL

* To be used in standard environmental Conditions.



Tower Light with different Mountings

Base Mounted

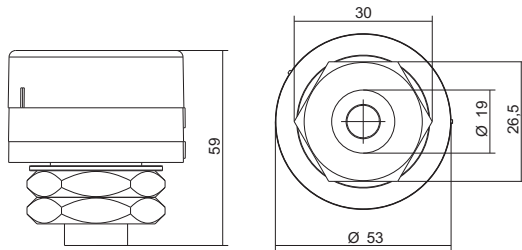

Wall Mounted Bracket

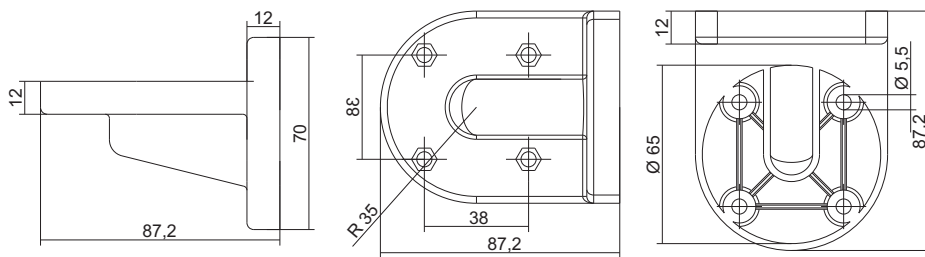

Swiveling

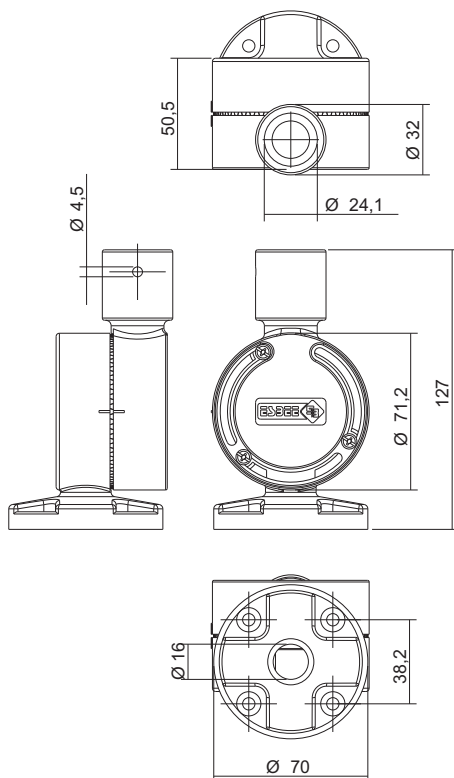

L Clamp

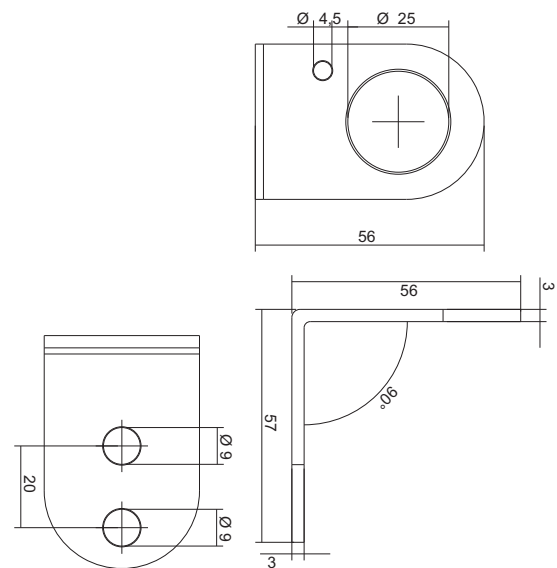



Limit Switch

SLPB Series

SLPBS3A1

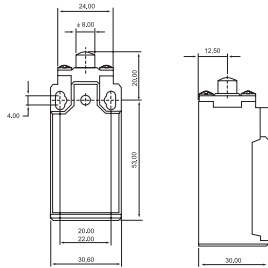

SLPBS3F5

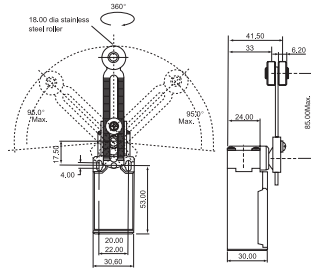

SLPBS3B2

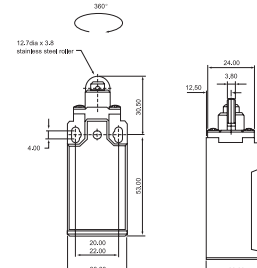

SLPBS3B4

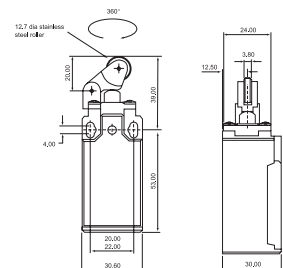

SLPBS3LP

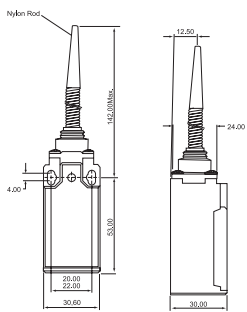

SLPBS3EE

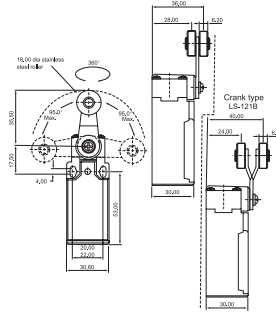

SLPBS3D

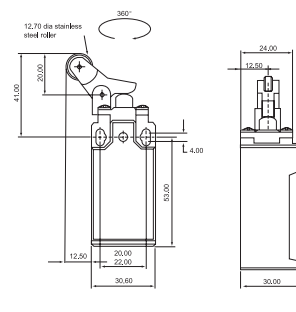

SLPBS3F7

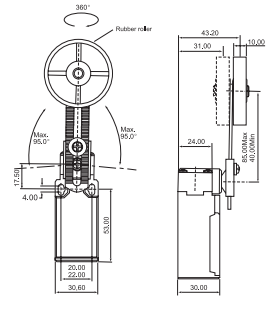

SLPS Series

SLPSS3A1

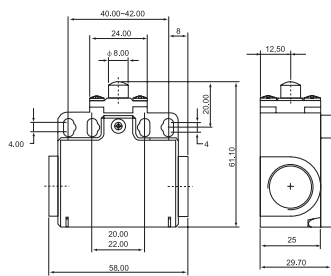

SLPSS3F6

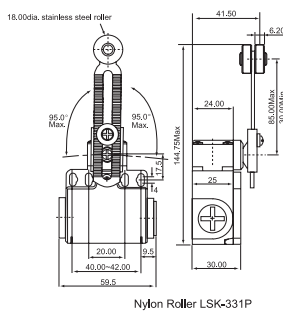

SLPSS3B2

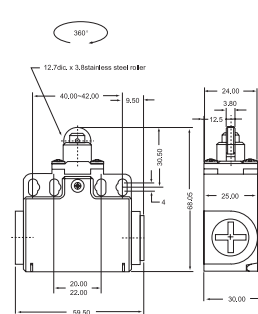

SLPSS3RM

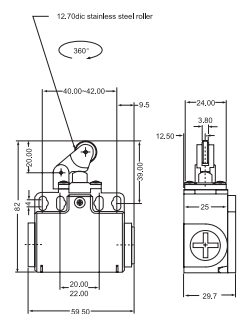

SLPSS3LP

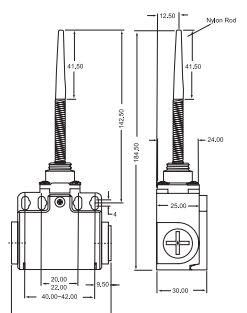

SLPSS3EE

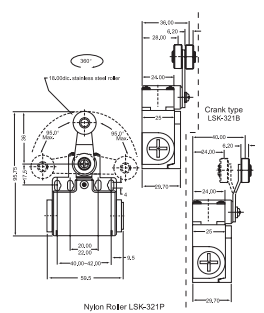

SLPSS3D

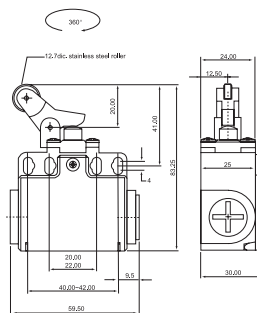

SLPSS3F7

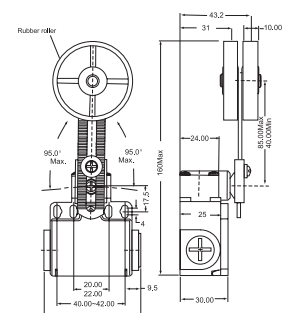



SLMPB Series

SLMPBS3D1

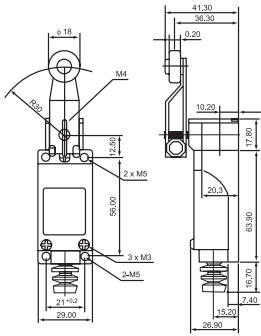

SLMPBS3F5

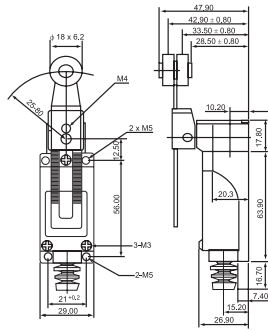

SLMPBS3A1

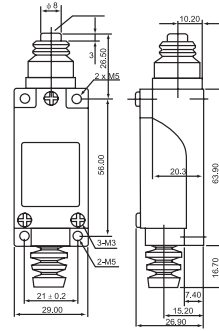

SLMPBS3B3

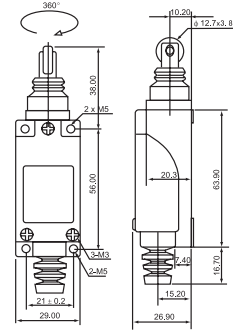

SLMPBS3B2

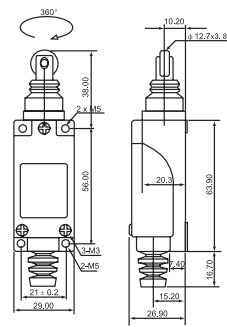

SLMPBS3M3

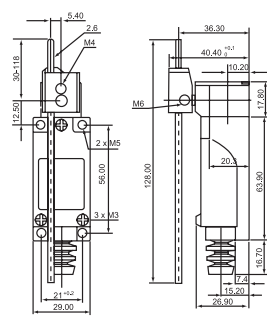

SLMPBS3M4

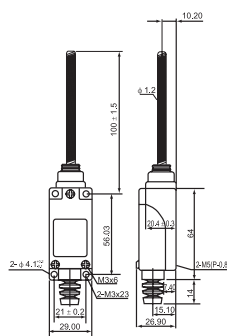

Characteristics

Operation speed	0.5mm-50cm/sec
Operating frequency	Mechanical: 120 operations/minute Electrical: 30 operations/minute
Contact resistance	25mΩ max. (initial value)
Insulation resistance	100mΩ min. (below 500VDC)
Dielectric strength	1000VAC, 50/60 Hz for 1 minute between terminals of the same polarity
	1500VAC, 50/60 Hz for 1 minute between current-carrying and non-current-carrying metal parts
	1500VAC, 50/60 Hz for 1 minute between each terminal and ground
Vibration	10-55Hz, 1.5mm double amplitude
Shock	Mechanical durable: 1,000m/Sec ² (about 100G'S) Malfunction: 300m/Sec ² (about 30G'S)
Ambient temperature	10~+70°C (With no icing)
Humidity	<95% RH
Life	Mechanical: 1 Million Electrical: 0.5 Million
Warranty	24 Months*
Degree of protection	IP65 (IEC Standard)

Utilization Category for Limit Switches

Kind of Current	Category	Typical Application
Alternative Current	AC-15	Control of Electromagnetic Load > 72 VA
Direct Current	DC-13	Control of Electromagnets

Contact Rating Designation Based on Utilization Categories

Designation	Utilization Category	Conventional Enclosed Thermal Current	Rated Operational Current (A) at Rated Operational Voltage						VA Ratings	
			120 V	240 V	380 V	480 V	500 V	600 V	Make	Break
Resistance Load			120 V	240 V	380 V	480 V	500 V	600 V	Make	Break
A300	AC-15	10	6	3	-	-	-	-	7200	720
Direct Current			125V	250 V		400 V	500 V	600 V	Make	Break
P600	DC-13	5	1.1	0.55		0.31	0.27	0.2	138	138

*Warranty against manufacturing defect



SLMB Series

SLMBS3D3

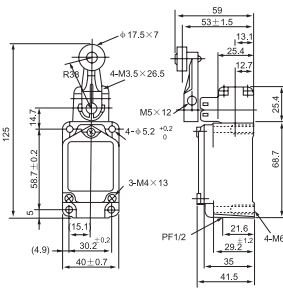

SLMBS3A2

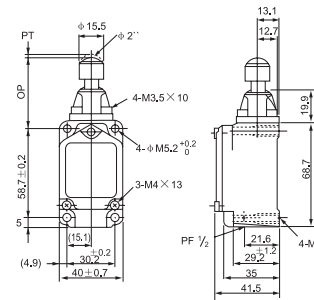

SLMBS3F6

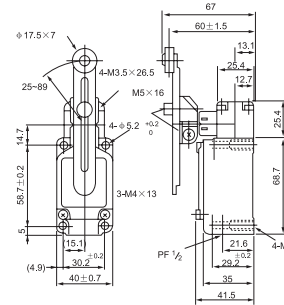

SLMBS3F7

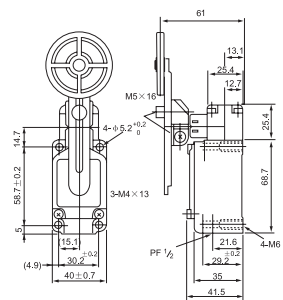

SLMBS3A3

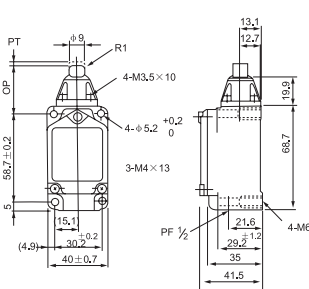

SLMBS3C3

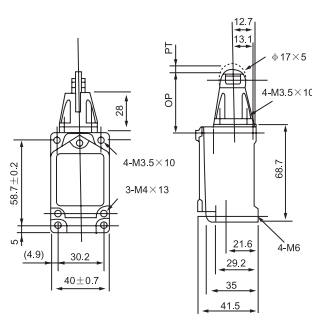

SLMBS3B5

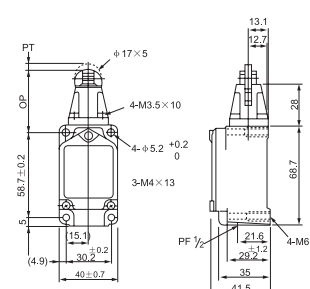

SLMBS3C4

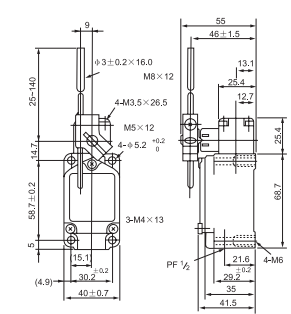

Characteristics

Operation speed	1mm-2m/s
Operating frequency	Mechanical: 120 operations/minute Electrical: 30 operations/minute
Contact resistance	15mΩ max. (initial value)
Insulation resistance	100mΩ min. (at 500VDC)
Dielectric strength	1000VAC, 50/60 Hz for 1 minute between terminals of the same polarity
	1500VAC, 50/60 Hz for 1 minute between each terminal and ground
Vibration	10-55Hz, 1.5mm double amplitude
Shock	Mechanical durable: 1,000m/Sec ² (about 100G'S) Malfunction: 300m/Sec ² (about 30G'S)
Ambient temperature	10~+80°C (With no icing)
Humidity	<95% RH
Life	Mechanical: 1 Million Electrical: 0.5 Million
Warranty	24 Months*
Degree of protection	IEC specification: IP66

Contact Rating Designation Based on Utilization Categories

Designation	Utilization Category	Conventional Enclosed Thermal Current	Rated Operational Current (A) at Rated Operational Voltage						VA Ratings	
			120 V	240 V	380 V	480 V	500 V	600 V	Make	Break
Resistance Load			120	240	380	480	500	600	Make	Break
A300	AC-15	10	6	3	-	-	-	-	7200	720
Direct Current			125V	250 V		400 V	500 V	600 V	Make	Break
P600	DC-13	5	1.1	0.55		0.31	0.27	0.2	138	138

Utilization Category for Limit Switches

Kind of Current	Category	Typical Application
Alternative Current	AC-15	Control of Electromagnetic Load > 72 VA
Direct Current	DC-13	Control of Electromagnets

*Warranty against manufacturing defect



SLMS Series

SLMSBS3B4

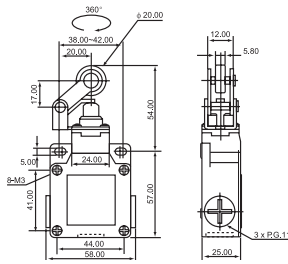

SLMSBS3E3

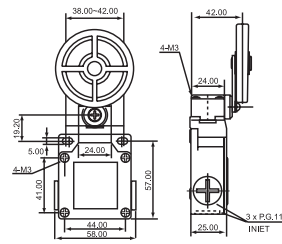

SLMSBS3A1

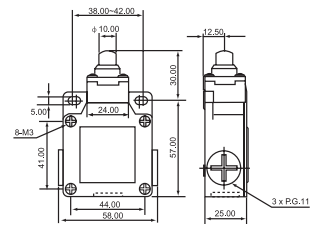

Characteristics	
Operation speed	0.5mm-50cm/sec
Operating frequency	Mechanical: 120 operations/minute Electrical: 30 operations/minute
Contact resistance	25mΩ max. (initial value)
Insulation resistance	100mΩ min. (below 500VDC)
Dielectric strength	1000VAC, 50/60 Hz for 1 minute between terminals of the same polarity
	1500VAC, 50/60 Hz for 1 minute between current-carrying and non-current-carrying metal parts
	1500VAC, 50/60 Hz for 1 minute between each terminal and ground
Vibration	10-55Hz, 1.5mm double amplitude
Shock	Mechanical durable: 1,000m/Sec ² (about 100G'S)
	Malfunction: 300m/Sec ² (about 30G'S)
Ambient temperature	10~+70°C (With no icing)
Humidity	95%RH <95% RH
Life	Mechanical: 1 Million Electrical: 0.5 Million
Warranty	24 Months*
Degree of protection	IP66 (IEC Standard)

Contact Rating Designation Based on Utilization Categories										
Designation	Utilization Category	Conventional Enclosed Thermal Current	Rated Operational Current (A) at Rated Operational Voltage						VA Ratings	
			120 V	240 V	380 V	480 V	500 V	600 V	Make	Break
Resistance Load			6	3	-	-	-	-	7200	720
A300	AC-15	10	6	3	-	-	-	-	7200	720
Direct Current			125V	250 V		400 V	500 V	600 V	Make	Break
P600	DC-13	5	1.1	0.55		0.31	0.27	0.2	138	138

Utilization Category for Limit Switches		
Kind of Current	Category	Typical Application
Alternative Current	AC-15	Control of Electromagnetic Load > 72 VA
Direct Current	DC-13	Control of Electromagnets

*Warranty against manufacturing defect



MLAS Series

MLASS3A1

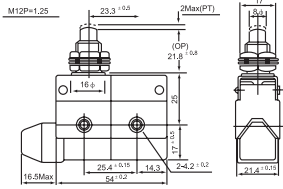

MLASS3B2

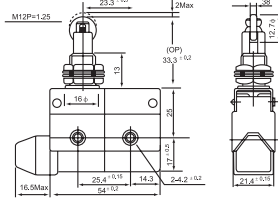

MLASS3C4

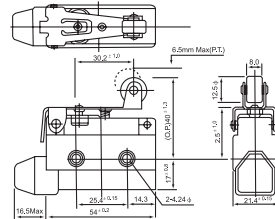

MLASS3C0

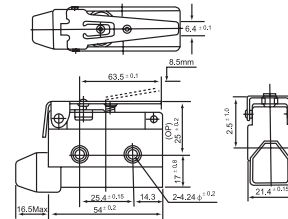

Characteristics	
Operation speed	0.5mm-50cm/sec
Operating frequency	Mechanical: 120 operations/minute Electrical: 30 operations/minute
Contact resistance	15mΩmax. (initial value)
Insulation resistance	100mΩ above (at 500VDC)
Dielectric strength	1000VAC, 50/60 Hz for 1 minute between terminals of the same polarity
	1500VAC, 50/60 Hz for 1 minute between current-carrying and non-current-carrying metal parts
Vibration	1500VAC, 50/60 Hz for 1 minute between each terminal and ground
	Action: 10 to 55Hz, 1.5mm pairs swing
Shock	Mechanical durable: 1, 000m/Sec ² (about 100g's) Malfunction: 300m/Sec ² (about 30g's)
Ambient temperature	10~+80°C (With no icing)
Humidity	< 95% RH
Life	Mechanical: 1 Million Electrical: 0.5 Million
Warranty	24 Months*
Weight	About 60g

Contact Rating Designation Based on Utilization Categories										
Designation	Utilization Category	Conventional Enclosed Thermal Current	Rated Operational Current (A) at Rated Operational Voltage						VA Ratings	
			120 V	240 V	380 V	480 V	500 V	600 V	Make	Break
Resistance Load			120	240	380	480	500	600	Make	Break
A300	AC-15	10	6	3	-	-	-	-	7200	720
Direct Current			125V	250 V		400 V	500 V	600 V	Make	Break
P600	DC-13	5	1.1	0.55		0.31	0.27	0.2	138	138

Utilization Category for Limit Switches		
Kind of Current	Category	Typical Application
Alternative Current	AC-15	Control of Electromagnetic Load > 72 VA
Direct Current	DC-13	Control of Electromagnets

*Warranty against manufacturing defect



MLPB Series

MLPBS3A2

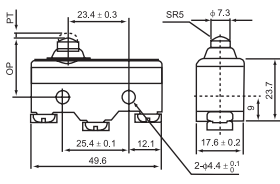

MLPBS3A3

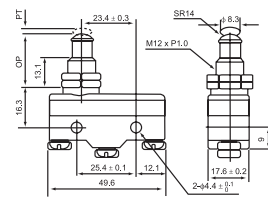

MLPBS3C2

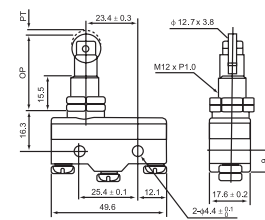

MLPBS3L3

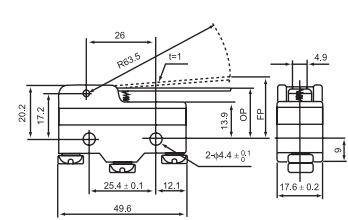

MLPBS3C1

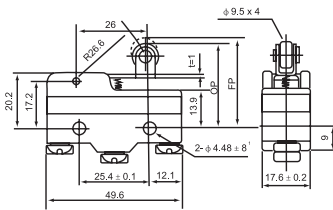

MLPBS3L4

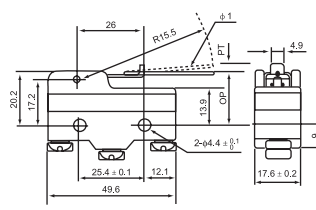

MLPBS3E5

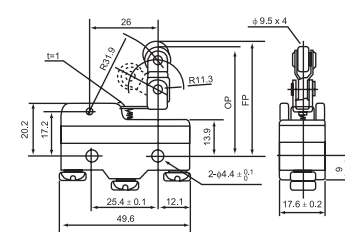

Characteristics	
Operation speed	0.01mm-1m/sec
Operating frequency	Mechanical: 240 operations/min. Electrical: 20 operations/min.
Contact resistance	15mΩ max. (initial value)
Insulation resistance	100mΩ min. (at 500VDC)
Dielectric strength	1000VAC, 50/60 Hz for 1 minute between terminals of the same polarity
	1500VAC, 50/60 HZ for 1 minute between current-carrying and non-current-carrying metal parts
Vibration	1500VAC, 50/60 HZ for 1 minute between each terminal and ground
	10-55Hz, 1.5mm double amplitude
Shock	Mechanical durable: 1,000m/Sec ² (about 100G'S)
	Malfunction: 300m/Sec ² (about 30G'S)
Ambient temperature	General purpose type: -25°C to +80°C (With no icing), Sealed type: -15°C to +80°C (With no icing)
Humidity	General purpose type: 85% RH max., Sealed type: 95% RH max.
Life	Mechanical: 1 Million Electrical: 0.5 Million
Warranty	24 Months*
Weight	About 22 to 58g

Contact Rating Designation Based on Utilization Categories										
Designation	Utilization Category	Conventional Enclosed Thermal Current	Rated Operational Current (A) at Rated Operational Voltage						VA Ratings	
			120 V	240 V	380 V	480 V	500 V	600 V	Make	Break
Resistance Load			120	240	380	480	500	600	Make	Break
A300	AC-15	10	6	3	-	-	-	-	7200	720
Direct Current			125V	250 V		400 V	500 V	600 V	Make	Break
P600	DC-13	5	1.1	0.55		0.31	0.27	0.2	138	138

Utilization Category for Limit Switches		
Kind of Current	Category	Typical Application
Alternative Current	AC-15	Control of Electromagnetic Load > 72 VA
Direct Current	DC-13	Control of Electromagnets

*Warranty against manufacturing defect



MNPS Series

MNPS3100D

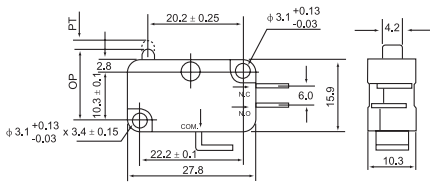

MNPS3101D

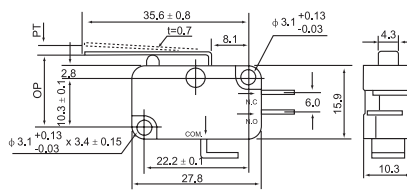

MNPS3103C

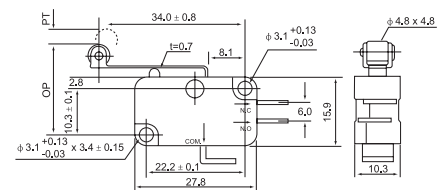

MNPS3100RD

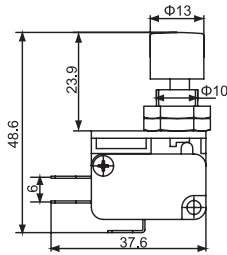

MNPS3100GD

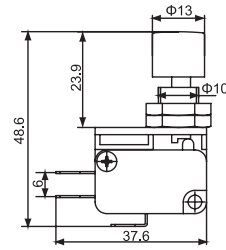

Characteristics

Item	Type	MNPS 10 type
Operation speed		0.1mm~1m/s (Button type)
Operating frequency		Mechanical:240 operations/min Electrical:20 operations/min
Insulation resistance		100mΩ above (at 500VDC)
Contact resistance		15mΩmax. (initial value)
Withstand voltage	Non-continuous terminals	1000VAC, 50/60 Hz for 1 minute
	current-carrying and non-current-carrying metal parts, Between terminal and earthing	1500VAC, 50/60 Hz for 1 minute
Vibration	Misoperation	10 to 55Hz, 1.5mm pairs swing
Shock	Durable	Maximum 1000 m/S ² (100G)
	Misoperation	Maximum 200 m/S ² (100G)
Life	Mechanical	1 Million
	Electrical	0.5 Million
Warranty		24 Months*
Temperature		-10~+70°C With no icing
Humidity		(+5~+35°C) Below 85% RH

Contact Rating Designation Based on Utilization Categories

Designation	Utilization Category	Conventional Enclosed Thermal Current	Rated Operational Current (A) at Rated Operational Voltage						VA Ratings	
			120 V	240 V	380 V	480 V	500 V	600 V	Make	Break
A300	AC-15	10	6	3	-	-	-	-	7200	720
P600	DC-13	5	1.1	0.55		0.31	0.27	0.2	138	138

Utilization Category for Limit Switches

Kind of Current	Category	Typical Application
Alternative Current	AC-15	Control of Electromagnetic Load > 72 VA
Direct Current	DC-13	Control of Electromagnets

*Warranty against manufacturing defect



Products for Elevators

LED Solutions

LED Torch

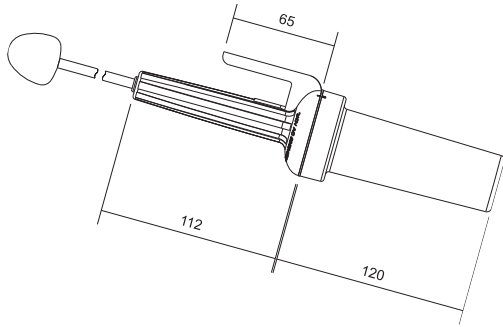

LED Torch with Hook

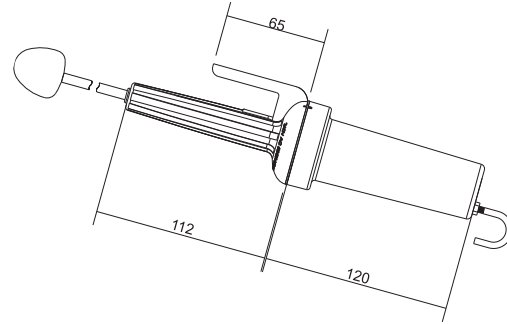

Product	LED Torch	High Illumination Torch
Rated Voltage	240V AC, 110V AC, 24V AC/DC	240V AC
Limit of Operating Voltage	-20% to +10% of Rated Voltage	-20% to +10% of Rated Voltage
LED's	SMD Power LED	SMD Power LED
Colours Available	White	White
Life / Warranty	50,000 Hours/24 Months*	50,000 Hours/24 Months*
LED Arrangement	Cluster	Cluster
Colour Temperature	6000°K- 7000°K	5700°K-6700°K
No. of LED's	24	16
Operating Frequency	50 / 60 Hz	50-60Hz
Operating Temperature	-25°C to 65°C	-250°C to 65°C
Storage Temperature	-30°C to 70°C	-250°C to 65°C
Surge Test	2 kV	1.5Kv
HV Test for 60 sec.	2.5 kV	1Kv
IP Protection	IP54	IP20 (With hook)/ IP54 (Without hook)
Power Consumption (240V)	3W	9W
Wire	0.50 Sq.mm	0.75 Sq.mm
Mounting	Hook arrangement is provided	Hook arrangement is provided
Watts	5W	9W
Illumination	100 LUX at 1 Meter	350 LUX at 1 Meter

*Warranty against manufacturing defect



Car Light

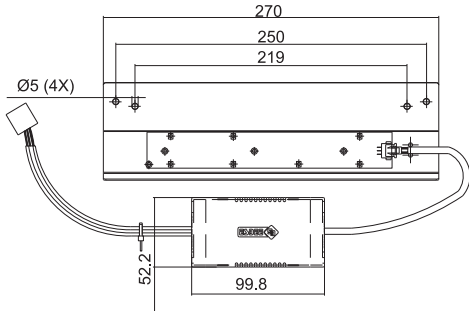

Test parameters	Specification
Rated Voltage	95-265V AC
LED's	SMD LED
Colours Available	White
Life / Warranty	50,000 Hours/24 Months*
Colour Temperature	5000°K -7000°K
Viewing Angle	120°
No. of LED Used	7
Operating Frequency	50 / 60 Hz
Operating Temperature	-25°C to 65°C
Storage Temperature	-30°C to 70°C
Surge Test	3kV
HV Test	2.5kV
EMI/EMC Protection	3kV
Input Power	19W
Output Voltage	21V DC
Electrical Efficiency	0.78%
Output Current	800 mA to 900 mA
Primary Overvoltage Protection	Available
Secondary short Circuit Protection	Available
Secondary open Circuit Protection	Available
Power Supply IP Protection Class	54

LED with Magnet

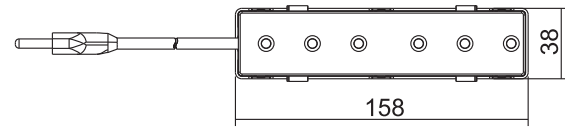

Test parameters	Specification
Rated Voltage	240V AC/110V AC
Limit of Operating Voltage	-20% to +10% of rated voltage
LED's	Through Hole LED's
Colour Available	White
Life / Warranty	50,000 Hours/24 Months*
Operating Temperature	-25°C to 65°C
Storage Temperature	-30°C to 70°C
Surge Test	3kV
HV Test for 60 sec.	2.5kV
Power Consumption (240V)	0.6W

*Warranty against manufacturing defect



Emergency Lighting

8 LED Strip

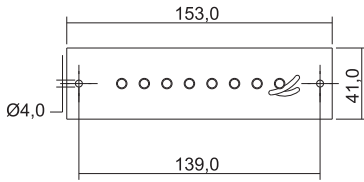

12 LED Strip

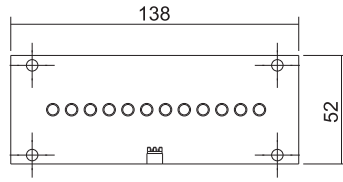

15 LED Strip

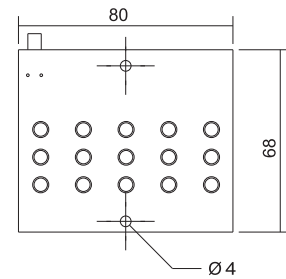

Product	8 LED PCB	12 LED PCB	15 LED PCB
Rated Voltage	12V DC	12V DC	12V DC
Limit of Operating Voltage	-20% to +10% of Rated voltage	-20% to +10% of Rated voltage	-20% to +10% of Rated voltage
No. of LED's	5 mm Through Hole 8 LEDs	5 mm Through Hole 12 LEDs	5 mm Through Hole 15 LEDs
Colours Available	White	White	White
Life / Warranty	50,000 Hours/24 Months*	50,000 Hours/24 Months*	50,000 Hours/24 Months*
Operating Temperature	-25°C to 65°C	-25°C to 65°C	-25°C to 65°C
Storage Temperature	-30°C to 70°C	-30°C to 70°C	-30°C to 70°C
HV Test for 60 sec.	2kV	2kV	2kV
Power Consumption	< 0.6W	< 0.6W	< 0.6W

*Warranty against manufacturing defect

Elevator Products

Pit Switches

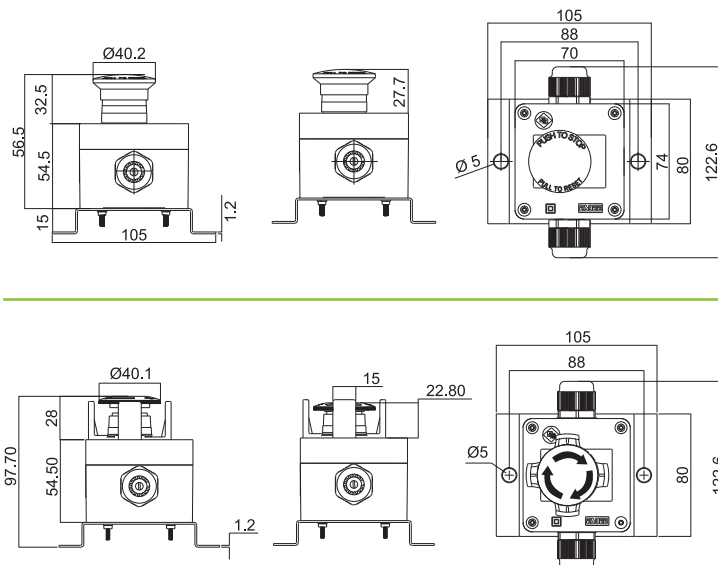

Car Top Box

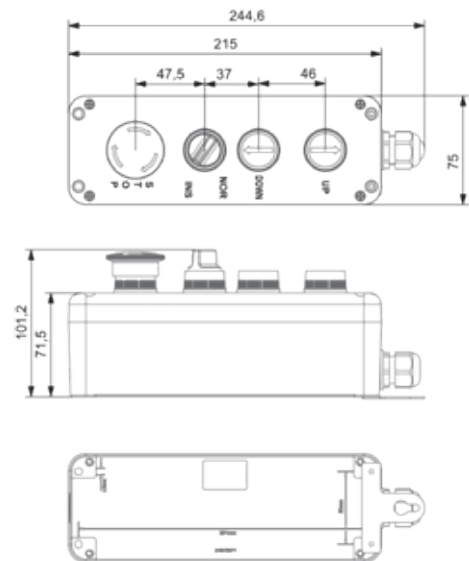



UL Correlation sheet for Gen Next Modular Actuator

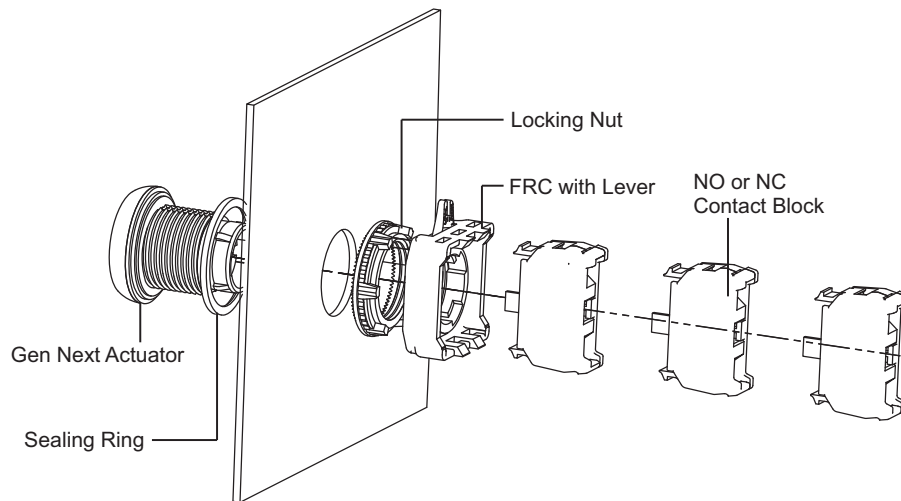

Flush Head	
Esbee CAT NO.	UL CAT NO.
EMNRFD1	EG02FD0R00
EMNGFD1	EG02FD0G00
EMNYFD1	EG02FD0Y00
EMNCFD1	EG02FD0C00
EMNbfd1	EG02FD0B00
EMNwfd1	EG02FD0W00
EMNAFD1	EG02FD0A00

Projecting Head Push Function	
Esbee CAT NO.	UL CAT NO.
EMNRPD1	EG02PD0R00
EMNGPD1	EG02PD0R00
EMNYPD1	EG02PD0R00
EMNCPD1	EG02PD0R00
EMNBPD1	EG02PD0R00
EMNwPD1	EG02PD0R00
EMNAPD1	EG02PD0R00

Lock & Key 2 Position	
Esbee CAT NO.	UL CAT NO.
EMNCKK1	EG02KK0C00
EMNCKR1	EG02KR0C00
EMNCKT1	EG02KT0C00
EMNCKL1	EG02KL0C00
EMNCKI1	EG02KI0C00
EMNCKJ1	EG02KJ0C00

Symetric Head	
Esbee CAT NO.	UL CAT NO.
EMNCSK1	EG02SK0C00
EMNCSR1	EG02SR0C00
EMNCST1	EG02ST0C00
EMNCSL1	EG02SL0C00
EMNCSI1	EG02SI0C00
EMNCSJ1	EG02SJ0C00

Lever Head	
Esbee CAT NO.	UL CAT NO.
EMNCLK1	EG02LK0C00
EMNCLR1	EG02LR0C00
EMNCLT1	EG02LT0C00
EMNCLL1	EG02LL0C00
EMNCLI1	EG02LI0C00
EMNCLJ1	EG02LJ0C00

Contact Blocks	
Esbee CAT NO.	UL CAT NO.
EC1C	EG08001C
EC2C	EG08002C

Mushroom Head Push Turn	
Esbee CAT NO.	UL CAT NO.
EMNRMH1	EG02MH0R00
EMNGMH1	EG02MH0G00
EMNYMH1	EG02MH0Y00
EMNCMH1	EG02MH0C00

Mushroom Head Push Function	
Esbee CAT NO.	UL CAT NO.
EMNRMD1	EG02MD0R00
EMNGMD1	EG02MD0G00
EMNYMD1	EG02MD0Y00
EMNCMD1	EG02MD0C00

UL Correlation sheet for Gen Next Entegral Actuator

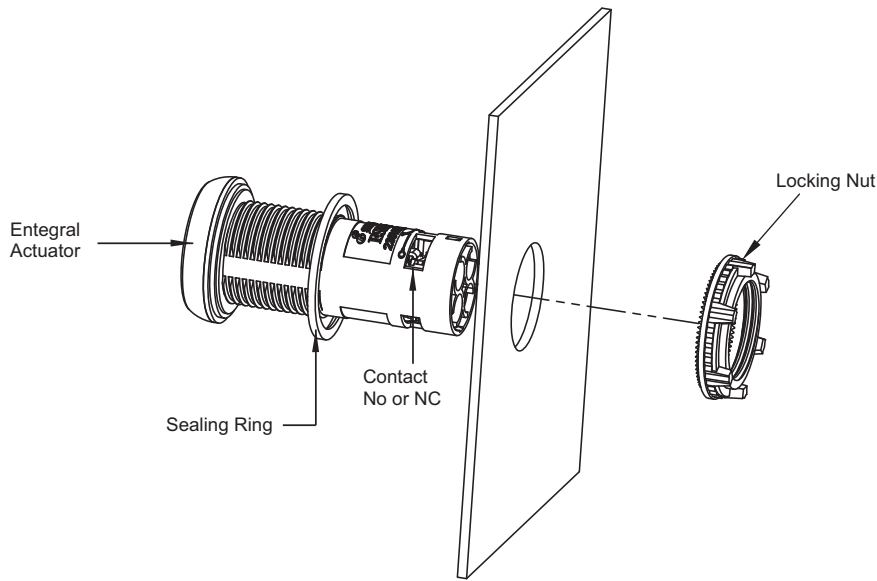

Mushroom Head Push Function

Esbee CAT NO.	UL CAT NO.
EE1RMD1	EE02MD1R
EE1GMD1	EE02MD1G
EE1YMD1	EE02MD1Y
EE1CMD1	EE02MD1C
EE2RMD1	EE02MD2R
EE2GMD1	EE02MD2G
EE2YMD1	EE02MD2Y
EE2CMD1	EE02MD2C
EE3RMD1	EE02MD3R
EE3GMD1	EE02MD3G
EE3YMD1	EE02MD3Y
EE3CMD1	EE02MD3C
EE4RMD1	EE02MD4R
EE4GMD1	EE02MD4G
EE4YMD1	EE02MD4Y
EE4CMD1	EE02MD4C
EE5RMD1	EE02MD5R
EE5GMD1	EE02MD5G
EE5YMD1	EE02MD5Y
EE5CMD1	EE02MD5C

Mushroom Head Push Turn

Esbee CAT NO.	UL CAT NO.
EE1RMH1	EE02MH1R
EE1GMH1	EE02MH1G
EE1YMH1	EE02MH1Y
EE1CMH1	EE02MH1C
EE2RMH1	EE02MH2R
EE2GMH1	EE02MH2G
EE2YMH1	EE02MH2Y
EE2CMH1	EE02MH2C
EE3RMH1	EE02MH3R
EE3GMH1	EE02MH3G
EE3YMH1	EE02MH3Y
EE3CMH1	EE02MH3C
EE4RMH1	EE02MH4R
EE4GMH1	EE02MH4G
EE4YMH1	EE02MH4Y
EE4CMH1	EE02MH4C
EE5RMH1	EE02MH5R
EE5GMH1	EE02MH5G
EE5YMH1	EE02MH5Y
EE5CMH1	EE02MH5C

Lock & Key 2 Position

Esbee CAT NO.	UL CAT NO.
EE1CKK1	EE02KK1C
EE1CKR1	EE02KR1C
EE1CKI1	EE02KI1C
EE2CKK1	EE02KK2C
EE2CKR1	EE02KR2C
EE2CKI1	EE02KI2C
EE3CKK1	EE02KK3C
EE3CKR1	EE02KR3C
EE3CKI1	EE02KI3C
EE4CKK1	EE02KK4C
EE4CKR1	EE02KR4C
EE4CKI1	EE02KI4C
EE5CKK1	EE02KK5C
EE5CKR1	EE02KR5C
EE5CKI1	EE02KI5C

Lock & Key 3 Position

Esbee CAT NO.	UL CAT NO.
EE3CKL1	EE02KL3C
EE3CKJ1	EE02KJ3C
EE6CKL1	EE02KL6C
EE6CKJ1	EE02KJ6C
EE4CKL1	EE02KL4C
EE4CKJ1	EE02KJ4C
EE5CKL1	EE02KL5C
EE5CKJ1	EE02KJ5C



UL Correlation sheet for Gen Next Integral Actuator

Flush Head	
Esbee CAT NO.	UL CAT NO.
EE1RFD1	EE02FD1R
EE1GFD1	EE02FD1G
EE1YFD1	EE02FD1Y
EE1CFD1	EE02FD1C
EE1BFD1	EE02FD1B
EE1WFD1	EE02FD1W
EE1AFD1	EE02FD1A
EE2RFD1	EE02FD2R
EE2GFD1	EE02FD2G
EE2YFD1	EE02FD2Y
EE2CFD1	EE02FD2C
EE2BFD1	EE02FD2B
EE2WFD1	EE02FD2W
EE2AFD1	EE02FD2A
EE3RFD1	EE02FD3R
EE3GFD1	EE02FD3G
EE3YFD1	EE02FD3Y
EE3CFD1	EE02FD3C
EE3BFD1	EE02FD3B
EE3WFD1	EE02FD3W
EE3AFD1	EE02FD3A
EE4RFD1	EE02FD4R
EE4GFD1	EE02FD4G
EE4YFD1	EE02FD4Y
EE4CFD1	EE02FD4C
EE4BFD1	EE02FD4B
EE4WFD1	EE02FD4W
EE4AFD1	EE02FD4A
EE5RFD1	EE02FD5R
EE5GFD1	EE02FD5G
EE5YFD1	EE02FD5Y
EE5CFD1	EE02FD5C
EE5BFD1	EE02FD5B
EE5WFD1	EE02FD5W
EE5AFD1	EE02FD5A

Lever Head 2 Position	
Esbee CAT NO.	UL CAT NO.
EE1CLK1	EE02LK1C
EE1CLI1	EE02LI1C
EE2CLK1	EE02LK2C
EE2CLI1	EE02LI2C
EE3CLK1	EE02LK3C
EE3CLI1	EE02LI3C
EE4CLK1	EE02LK4C
EE4CLI1	EE02LI4C
EE5CLK1	EE02LK5C
EE5CLI1	EE02LI5C

Projecting Head Push Function	
Esbee CAT NO.	UL CAT NO.
EE1RPD1	EE02PD1R
EE1GPD1	EE02PD1G
EE1YPD1	EE02PD1Y
EE1CPD1	EE02PD1C
EE1BPD1	EE02PD1B
EE1WPD1	EE02PD1W
EE1APD1	EE02PD1A
EE2RPD1	EE02PD2R
EE2GPD1	EE02PD2G
EE2YPD1	EE02PD2Y
EE2CPD1	EE02PD2C
EE2BPD1	EE02PD2B
EE2WPD1	EE02PD2W
EE2APD1	EE02PD2A
EE3RPD1	EE02PD3R
EE3GPD1	EE02PD3G
EE3YPD1	EE02PD3Y
EE3CPD1	EE02PD3C
EE3BPD1	EE02PD3B
EE3WPD1	EE02PD3W
EE3APD1	EE02PD3A
EE4RPD1	EE02PD4R
EE4GPD1	EE02PD4G
EE4YPD1	EE02PD4Y
EE4CFD1	EE02PD4C
EE4BFD1	EE02PD4B
EE4WFD1	EE02PD4W
EE4AFD1	EE02PD4A
EE5RPD1	EE02PD5R
EE5GPD1	EE02PD5G
EE5YFD1	EE02PD5Y
EE5CFD1	EE02PD5C
EE5BFD1	EE02PD5B
EE5WFD1	EE02PD5W
EE5AFD1	EE02PD5A

Lever Head 3 Position	
Esbee CAT NO.	UL CAT NO.
EE3CLL1	EE02LL3C
EE3CLJ1	EE02LJ3C
EE6CLL1	EE02LL6C
EE6CLJ1	EE02LJ6C
EE4CLL1	EE02LL4C
EE4CLJ1	EE02LJ4C
EE5CLL1	EE02LL5C
EE5CLJ1	EE02LJ5C

Symmetric Head 2 Position	
Esbee CAT NO.	UL CAT NO.
EE1CSK1	EE02SK1C
EE1CSR1	EE02SR1C
EE1CSI1	EE02SI1C
EE2CSK1	EE02SK2C
EE2CSR1	EE02SR2C
EE2CSI1	EE02SI2C
EE3CSK1	EE02SK3C
EE3CSR1	EE02SR3C
EE3CSI1	EE02SI3C
EE4CSK1	EE02SK4C
EE4CSR1	EE02SR4C
EE4CSI1	EE02SI4C
EE5CSK1	EE02SK5C
EE5CSR1	EE02SR5C
EE5CSI1	EE02SI5C
EE4CMD1	EE02MD4C
EE5RMD1	EE02MD5R
EE5GMD1	EE02MD5G
EE5YMD1	EE02MD5Y
EE5CMD1	EE02MD5C

Symmetric Head 3 Position	
Esbee CAT NO.	UL CAT NO.
EE6CSL1	EE02SL6C
EE6CSJ1	EE02SJ6C
EE4CSL1	EE02SL4C
EE4CSJ1	EE02SJ4C
EE5CSL1	EE02SL5C
EE5CSJ1	EE02SJ5C



Website



LinkedIn



Esbee Electrotech LLP,

Corporate office: S-42/1, M.I.D.C Bhosari, Pune - 411026

Plant 1: S-42/1, M.I.D.C Bhosari, Pune - 411026, Maharashtra, India

Plant 2: J-159, M.I.D.C Bhosari, Pune - 411026, Maharashtra, India

Plant 3: C-29, M.I.D.C Ahmednagar - 414111, Maharashtra, India

Email: info@esbee-electrotech.com | Website: www.esbee-electrotech.com